

Historic, archived document

Do not assume content reflects current scientific knowledge, policies, or practices.

n 82
BULLETIN No. 1.—NEW SERIES. (THIRD EDITION.)

U. S. DEPARTMENT OF AGRICULTURE.
DIVISION OF ENTOMOLOGY.

THE HONEY BEE:

A MANUAL OF

INSTRUCTION IN APICULTURE.

BY

FRANK BENTON, M. S.,
ASSISTANT ENTOMOLOGIST.



WASHINGTON:
GOVERNMENT PRINTING OFFICE.

1899.

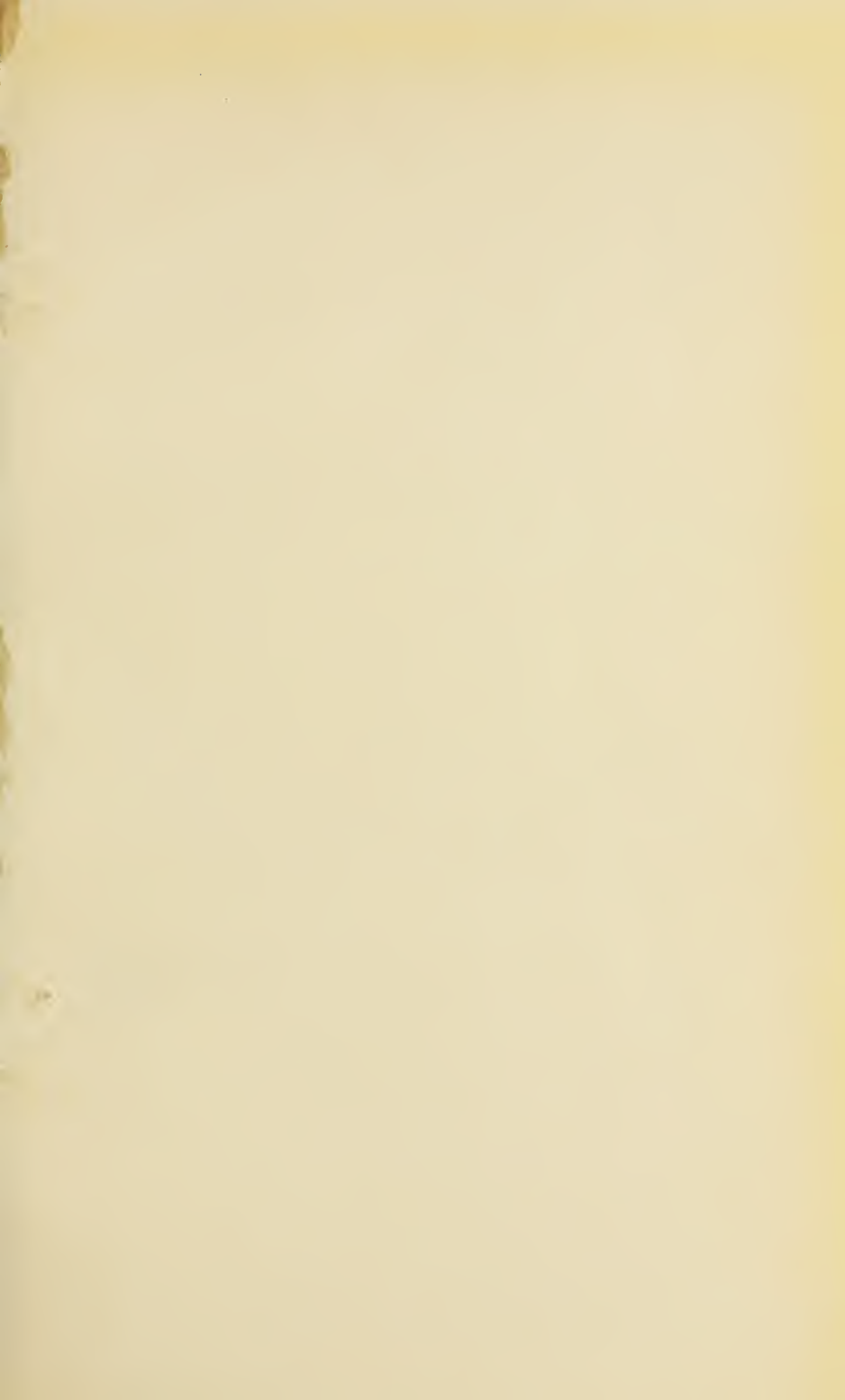



AN APIARY IN MARYLAND.

BULLETIN No. 1.—NEW SERIES. (THIRD EDITION.)

U. S. DEPARTMENT OF AGRICULTURE.
DIVISION OF ENTOMOLOGY.

THE HONEY BEE:

A MANUAL OF

INSTRUCTION IN APICULTURE.

BY

FRANK BENTON, M. S.,
ASSISTANT ENTOMOLOGIST.



WASHINGTON :
GOVERNMENT PRINTING OFFICE.
1899.

LETTER OF TRANSMITTAL.

U. S. DEPARTMENT OF AGRICULTURE,
DIVISION OF ENTOMOLOGY,
Washington, D. C., May 27, 1899.

SIR: I have the honor to transmit herewith for republication a manual entitled, *The Honey Bee: A Manual of Instruction in Apiculture*, by Mr. Frank Benton, who has been in charge of the apiarian work of this Division for several years. The constant demand for information concerning bee culture for a long time indicated a need for such a public manual, and the work was begun and nearly completed under the direction of my predecessor, Dr. C. V. Riley. The manuscript was submitted September 20, 1895, and the edition of 1,000 copies was soon exhausted. In April, 1896, Congress ordered a reprint of 20,000 copies, in which some corrections and additions were made by the author. He has also taken advantage of the reprint of another (the third) edition to make some slight additional changes.

The apiarian industry in the United States is practically a development of the last forty years, although isolated individuals were engaged in this work long prior to that time. The importance of the industry at the present day is not generally realized, and the following figures will probably be surprising to many well-informed individuals:

Apiarian societies in the United States.....	110
Apiarian journals.....	8
Steam factories for the manufacture of beehives and apiarian implements.....	15
Honey produced in the United States in 1869 (according to United States Census Report)..... pounds..	14, 702, 815
Honey produced in the United States in 1889 (according to United States Census Report)..... pounds..	63, 894, 186
Persons engaged in the culture of bees (estimated).....	300, 000
Honey and wax produced, at wholesale rates (Eleventh Census).....	\$7, 000, 000
Mr. Benton's estimate of the present annual value of apiarian products..	\$20, 000, 000

As supplementary to these figures it may be stated that in addition to the 15 steam-power factories there is a very large number of smaller factories, using mainly hand and horse power, which are engaged in the production of supplies, such as hives, smokers, honey extractors, sections, comb foundation, and other apiarian apparatus. It is estimated by Mr. Benton that the present existing flora of the United States could undoubtedly support, with the same average profit, ten times the

number of colonies of bees it now supports. This branch of agricultural industry does not impoverish the soil in the least, but, on the contrary, results in better seed and fruit crops. The total money gain to the country from the prosecution of this industry would undoubtedly be placed at several times the amount given in the table above were we only able to estimate in dollars and cents the result of the work of bees in cross fertilizing the blossoms of fruit crops. In support of this it is only necessary to refer to the fact that recent investigations by another division of this Department have shown that certain varieties of pear are nearly or quite sterile unless bees bring pollen from other distinct varieties for their complete cross fertilization.

I respectfully recommend the publication of this manual as No. 1 of the new series of bulletins of this Division.

Respectfully,

L. O. HOWARD,
Entomologist.

Hon. JAMES WILSON,
Secretary of Agriculture.

PREFACE.

This treatise is designed to make the practical management of an apiary plain to those whose acquaintance with the subject is limited, and to direct such as may find in it a pleasant and profitable occupation to a system of management which may be followed on an extensive scale with the certainty of fair remuneration for the labor and capital required. With this object in view the author has deemed it best to treat the natural history of the bee but briefly, and also to give little space to matters which are in question, or to different methods of accomplishing given results, or to such as are only adapted to a limited portion of the country, but rather to explain one settled way widely applicable and which will lead to success. The methods advised here are such as the author has found practical during an extended experience, yet in regard to numerous details many works—both foreign and American—have been consulted, none more freely than Langstroth on the Honey Bee, revised by Chas. Dadant & Son, and Bees and Bee Keeping, by Prof. F. R. Cheshire.

Many of the illustrations were specially prepared for this bulletin. Some have been taken from publications of the Department of Agriculture. These include some of the smaller illustrations of honey-producing plants and also Plates III to X, which are from reports of the Botanist of the Department. Plates II and XI, and figures 5, 6, 8, 44, 50, 51, and 76 are copied from Cheshire; figs. 68 and 69 from Simmins. The Department is also under obligations to the A. I. Root Company, to Chas. Dadant & Son, T. F. Bingham, Hayck Bros., Van Allen & Williams, and Dr. T. L. Tinker, for electrotypes.

FRANK BENTON.

WASHINGTON, D. C.

CONTENTS.

	Page.
CHAPTER I.—Classification of the honey bee.....	11
The different species and races	11
Common East Indian honey bee, <i>Apis indica</i>	12
Tiny East Indian honey bee, <i>Apis florea</i>	13
Giant East Indian honey bee, <i>Apis dorsata</i>	13
Common hive or honey bee, <i>Apis mellifera</i>	15
Cyprians	15
Italians	16
Carniolans	17
German, common black or brown bees.....	18
CHAPTER II.—Kinds of bees composing a colony—Bee products and description of combs—Development of brood.....	19
Kinds of bees in a colony	19
Bee products and organs used in their preparation.....	21
Nectar and honey.....	22
Propolis	24
Bee poison and the sting.....	24
Water.....	25
Silk	25
Wax.....	25
Combs.....	26
Development of brood.....	28
The worker	29
The drone.....	30
CHAPTER III.—Quieting and manipulating bees.....	31
CHAPTER IV.—Establishing an apiary: Time—Selecting hives of bees—Moving bees—Selection of site.....	35
Selection of stocks.....	35
Moving bees.....	37
Selection of site.....	38
CHAPTER V.—Hives and implements.....	40
Hives.....	40
Implements	47
Bee smokers	47
Veils	48
Honey extractors and honey knives.....	49
Wax extractors.....	50
Queen introducing-cages	50
Bee feeders	51
Section folders.....	52
Bee escapes	52
Foundation fasteners.....	52
Comb-foundation machines.....	54

	Page.
CHAPTER VI.—Bee pasturage.....	56
Cultivation of honey plants.....	59
Bees as cross fertilizers.....	62
Honey and pollen producing plants.....	64
CHAPTER VII.—Spring manipulation.....	69
Transferring.....	71
Queenlessness in spring.....	74
CHAPTER VIII.—Securing surplus honey and wax.....	75
Extracted honey.....	75
Comb honey.....	79
Putting on sections.....	81
Production of wax.....	84
CHAPTER IX.—Rearing and introducing queens.....	87
Mailing queens.....	92
Introducing queens.....	93
CHAPTER X.—Increase of colonies.....	95
Natural swarming.....	95
Clipping queens.....	97
Automatic hivers.....	98
Prevention of after-swarmling.....	98
Artificial increase.....	99
Dividing.....	100
Driving or brushing.....	100
The nucleus system.....	101
Prevention of swarming.....	101
Dequeening.....	102
Requeening.....	102
Space near entrances.....	103
Langdon non-swarmling device.....	104
Selection in breeding.....	105
CHAPTER XI.—Wintering bees.....	106
Outdoor wintering.....	109
Indoor wintering.....	111
CHAPTER XII.—Diseases and enemies of bees.....	112
Diarrhea and dysentery.....	112
Foul brood.....	112
The wax moth.....	113
Braula or bee louse.....	115
Other enemies.....	115
Robber flies, dragon flies, etc.....	115
Ants and wasps.....	115
Spiders.....	116
Toads and lizards.....	116
Birds.....	116
Mammals.....	116
Robber bees.....	116
Laying workers.....	117
Brief list of books and journals relating to apiculture.....	118

ILLUSTRATIONS.

PLATES.

	Page.
An apiary in Maryland	Frontispiece.
PLATE I.—Honey bees	16
II.—Digestive system of bee	22
III.—Alfalfa (<i>Medicago sativa</i>)	64
IV.—Esparcet or sainfoin (<i>Onobrychis sativa</i>)	64
V.—Sweet clover or melilot (<i>Melilotus alba</i>)	64
VI.—Acacia (<i>Acacia constricta</i>)	64
VII.—Mesquite (<i>Prosopis juliflora</i>)	64
VIII.—Blue weed or viper's bugloss (<i>Echium vulgare</i>)	64
IX.—Crimson clover (<i>Trifolium incarnatum</i>)	64
X.—Alsike clover (<i>Trifolium hybridum</i>)	64
XI.—Bacillus alvei	112

TEXT FIGURES.

FIG. 1. Worker cells of common East Indian honey bee (<i>Apis indica</i>)	12
2. Worker cells of tiny East Indian honey bee (<i>Apis florea</i>)	13
3. Comb of tiny East Indian honey bee (<i>Apis florea</i>)	14
4. Worker cells of common honey bee (<i>Apis mellifera</i>)	15
5. Ovaries of queen and workers	19
6. Heads of queen and drone	20
7. Modifications of the legs of different bees	21
8. Head and tongue of <i>Apis mellifera</i> worker	22
9. Wax disks of social bees	26
10. Comb building, side of hive removed	27
11. Cross section of brood apartment	29
12. Use of veil and bee smoker	31
13. Manipulation—removing comb from hive	32
14. Manipulation—tilting to bring reverse side of comb to view	33
15. Manipulation—reverse side of comb brought to view	33
16. Manipulation—examining reverse side of comb	33
17. Quinby closed-end frames	34
18. Box hive prepared for transportation	37
19. Frame hive prepared for transportation	37
20. An apiary in Florida	38
21. An apiary in California	39
22. Ancient Greek movable comb hive	41
23. Dadant-Quinby form of Langstroth hive with cap and gable roof	41
24. Langstroth frame—showing construction	42
25. Form in which to nail frames	42
26. Lock-joint chaff hive	43
27. Manner of nailing hives	43

	Page.
FIG. 28. Section of improved tin frame-rest.....	44
29. The Langstroth hive (Dadant-Quinby form), cross section showing construction.....	45
30. The Nonpareil hive.....	46
31. Dadant-Quinby form of Langstroth hive—open.....	46
32. The Bingham bee smoker.....	48
33. Automatic reversible honey extractor.....	49
34. Quinby uncapping knife.....	49
35. Bingham & Hetherington uncapping knife.....	49
36. Excelsior wax extractor.....	50
37. Simplicity feeder.....	51
38. Fruit-jar bee feeder, bottom of feeding stage and perforated cap shown separately.....	51
39. The Porter spring bee escape.....	52
40. Daisy foundation fastener.....	53
41. Fastening starter of comb foundation in frame.....	53
42. Spur wire-embedder.....	54
43. Comb-foundation machine.....	55
44. Willow herb (<i>Epilobium angustifolium</i>).....	57
45. Wagner's flat pea (<i>Lathyrus sylvestris wagneri</i>).....	59
46. Dwarf Essex or winter rape (<i>Brassica napus</i>).....	60
47. Summer or bird rape (<i>Brassica napus</i>).....	60
48. Sacaline or giant knotweed (<i>Polygonum sachalinense</i>).....	61
49. Russian or hairy vetch (<i>Vicia villosa</i>).....	61
50. Mountain laurel (<i>Kalmia latifolia</i>).....	63
51. Apple (<i>Pyrus malus</i>).....	63
52. Heath-like wild aster (<i>Aster ericoides</i>).....	64
53. Transferring—drumming the bees from a box hive into a frame hive.....	71
54. Transferred comb and inserted queen cell.....	73
55. Uncapping and extracting honey.....	77
56. One-piece "V"-grooved sections.....	80
57. Super with section holders and sections in place.....	80
58. Dadant-Quinby form of Langstroth hive, elevated from bottom board and slid back for ventilation in summer.....	82
59. Langstroth hive with combined surplus case and shipping crate.....	83
60. Honey shipping cases.....	83
61. Boardman solar wax extractor.....	85
62. Comb showing worker brood and queen cells.....	88
63. Queen cells and worker brood in various stages.....	89
64. The Benton queen cage for transporting a queen and attendants by mail.....	92
65. Caging a queen for mailing.....	92
66. Queen introducing-cage.....	94
67. Hiving a swarm of bees.....	96
68. The Simmins non-swarmer system, single-story hive with supers.....	103
69. The Simmins non-swarmer system, double-story hive with supers.....	103
70. Beehives with Langdon nonswarmer attached.....	104
71. Percolator for preparation of winter food.....	107
72. The American straw hive of Hayek Bros.....	108
73. Davis hive with newspapers packed between inner and outer cases and brood frames on end for winter.....	108
74. Double-walled hive adapted to outdoor wintering as well as summer use below 40° north latitude in United States.....	109
75. An apiary in Vermont—winter view.....	110
76. Cheshire antirobbing entrance.....	117

MANUAL OF APICULTURE.

CHAPTER I.

CLASSIFICATION OF THE HONEY BEE

THE DIFFERENT SPECIES AND RACES.

A knowledge of the structural peculiarities and the life history of bees will aid anyone who essays to manage them for profit in determining more accurately what conditions are necessary to their greatest welfare. It is not to be understood that such knowledge will take the place of an acquaintance with those conditions under which actual practice has shown that bees thrive, but that it forms a good basis for an understanding of whatever practice has found best in the management of these industrious and profitable insects. It will also assist in pointing out in what way practice can be improved.

In a small treatise like the present one, the object of which is to give in plain language the information needed by one who engages in bee keeping primarily for profit, it is not possible to do more than present a mere outline of classification and a few general facts regarding structure. The reader who finds them interesting and valuable in his work is reminded that the treatment of these matters in more extended volumes, such as Langstroth's, Cheshire's, etc., will be found far more so.

Singling out from the order Hymenoptera, or membranous-winged insects, the family Apidæ, or bee family, several marked types called genera are seen to compose it, such as *Apis* (the hive bee), *Bombus* (the bumble bee), *Xylocopa* (the carpenter bee), *Megachile* (the leaf-cutter), *Melipona* (the stingless honey bee of the American tropics), etc. All of these are very interesting to study, and each fulfills a purpose in the economy of nature; but the plan of these pages can only be to consider the first genus, *Apis*, or the hive bee. Incidentally it may be mentioned that the plan of introducing the stingless bees (*Melipona*) from tropical America has frequently been brought up with the expectation of realizing important practical results from it. These bees might possibly be kept in the warmer portions of our country, but their honey yield is small, not well ripened, and not easily harvested in good shape, since the honey cells are of dark wax, like that made by our bumble bees, and they are not arranged in regular order, but in irregular clumps like those of bumble bees. The writer had a colony under observation last year, and experiments have been made with them in their native lands as well as in European countries. Of the genus *Apis* the only representative in this country is *mellifera*, although several others are natives of Asia and Africa.

THE COMMON EAST INDIAN HONEY BEE.

(Apis indica Fab.)

The common bee of southern Asia is kept in very limited numbers and with a small degree of profit in earthen jars and sections of hollow trees in portions of the British and Dutch East Indies. They are also found wild, and build when in this state in hollow trees and in rock clefts. Their combs, composed of hexagonal wax cells, are ranged parallel to each other like those of *A. mellifera*, but the worker brood cells are smaller than those of our ordinary bees, showing 36 to the square inch of surface instead of 29, while the comb where worker brood is reared, instead of having, like that of *A. mellifera*, a thickness of seven-eighths inch, is but five-eighths inch thick. (Fig. 1.)



FIG. 1.—Worker cells of common East Indian honey bee (*Apis indica*); natural size. (Original.)

The workers.—The bodies of these, three-eighths inch long when empty, measure about one-half inch when dilated with honey. The thorax is covered with brownish hair and the shield or crescent between the wings is large and yellow. The abdomen is yellow underneath. Above it presents a ringed appearance, the anterior part of each segment being orange yellow, while the posterior part shows bands of brown of greater or less width and covered with whitish-brown hairs; tip black. They are nimble on foot and on the wing, and active gatherers.

The queens.—The queens are large in proportion to their workers and are quite prolific; color, leather or dark coppery.

The drones.—These are only slightly larger than the workers; color, jet-like blue black, with no yellow, their strong wings showing changing hues like those of wasps.

Manipulations with colonies of these bees are easy to perform if smoke be used, and though they are more excitable than our common hive bees, this peculiarity does not lead them to sting more, but seems rather to proceed from fear. The sting is also less severe.

Under the rude methods thus far employed in the management of this bee no great yields of honey are obtained, some 10 or 12 pounds having been the most reported from a single hive. It is quite probable that if imported into this country it would do more. These bees would no doubt visit many small flowers not frequented by the hive bees we now have, and whose nectar is therefore wasted, but very likely they might not withstand the severe winters of the North unless furnished with such extra protection as would be afforded by quite warm cellars or special repositories.

THE TINY EAST INDIAN HONEY BEE.

(Apis florea Fab.)

This bee, also a native of East India, is the smallest known species of the genus. It builds in the open air, attaching a single comb to a twig of a shrub or small tree. This comb is only about the size of a man's hand and is exceedingly delicate, there being on each side 100 worker cells to the square inch of surface (figs. 2 and 3). The workers, more slender than house flies, though longer bodied, are blue-black in color, with the anterior third of the abdomen bright orange. Colonies of these bees accumulate so little surplus honey as to give no hope that their cultivation would be profitable.

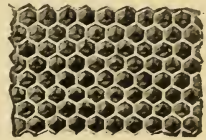

THE GIANT EAST INDIAN HONEY BEE.

(Apis dorsata Fab.)

This large bee (Plate I, figs. 2 and 3), which might not be inappropriately styled the Giant East Indian bee, has its home also in the far East—both on the continent of Asia and the adjacent islands. There are probably several varieties, more or less marked, of this species, and very likely *Apis zonata* Guér. of the Philippine Islands, reported to be even larger than *A. dorsata*, will prove on further investigation to be only a variety of the latter. All the varieties of these bees build huge combs of very pure wax—often 5 to 6 feet in length and 3 to 4 feet in width, which they attach to overhanging ledges of rocks or to large limbs of lofty trees in the primitive forests or jungles. When attached to limbs of trees they are built singly and present much the same appearance as those of the tiny East Indian bee, shown in the accompanying figure (fig. 3). The Giant bee, however, quite in contradistinction to the other species of *Apis* mentioned here, does not construct larger cells in which to rear drones, these and the workers being produced in cells of the same size. Of these bees—long a sort of a myth to the bee keepers of America and Europe—strange stories have been told. It has been stated that they build their combs horizontally, after the manner of paper-making wasps; that they are so given to wandering as to make it impossible to keep them in hives, and that their ferocity renders them objects greatly to be dreaded. The first real information regarding these points was given by the author. He visited India in 1880-81 for the purpose of obtaining colonies of *Apis dorsata*. These were procured in the jungles, cutting the combs from their original

FIG. 2.—Worker cells of tiny East Indian honey bee (*Apis florea*); natural size. (Original).

attachments, and it was thus ascertained that (as might have been expected in the case of any species of *Apis*), their combs are always built perpendicularly; also that the colonies placed in frame hives and permitted to fly freely did not desert these habitations and that, far from being ferocious, these colonies were easily handled by proper precautions, without even the use of smoke. It was also proved by the quantity of honey and wax present that they are good gatherers. The execution at that time of the plan of bringing these bees to the United States was prevented only by severe illness contracted in India.

These large bees would doubtless be able to get honey from flowers whose nectaries are located out of reach of ordinary bees, notably those of the red clover, now visited chiefly by bumble bees and which it

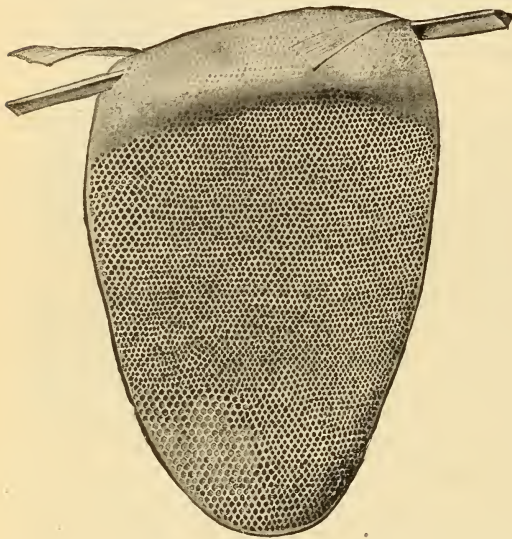

FIG. 3.—Comb of tiny East Indian honey bee (*Apis florea*); one-third natural size. (Original.)

is thought the East Indian bees might pollinate and cause to produce seed more abundantly. Even if no further utilizable, they might prove an important factor in the production in the Southern States of large quantities of excellent beeswax, now such an expensive article. Should these bees and the common East Indian bee (*Apis indica*), previously referred to, visit in the main only such flowers as are not adapted to our hive bees, their introduction, wherever it could be made successful, would, without decreasing the yield from our

hive bees, add materially to the honey and wax production of the country. Theoretical conclusions as to the results of such an introduction can not be of much account unless based upon an intimate acquaintance with the nature and habits of the bees to be introduced. Enough is known of the small bee to remove all doubt regarding the possibility of its successful introduction, and it is also probable that the large one would prove valuable. In neither case does there appear any possibility that evil results might follow their introduction. There are also numerous other varieties or species of bees in Africa and Asia about which no more or even less is known, but to investigate them fully will require much time and considerable expense. It is a subject, however, that should receive careful consideration because of the possible benefits to apiculture and the wider beneficial effects on agriculture.

THE COMMON HIVE OR HONEY BEE.

(Apis mellifera Linn.)

Besides the common brown or German bee imported from Europe to this country some time in the seventeenth century and now widely spread from the Atlantic to the Pacific, several other races have been brought here—the Italian in 1860, and later the Egyptian, the Cyprian, the Syrian, the Palestine, the Carniolan (Plate I, figs. 1, 4, and 5), and the Tunisian. Of these the brown or German, the Italian, and, in a few apiaries, the Carniolan bees are probably the only races existing pure in the United States, the others having become more or less hybridized with the brown race or among themselves or their cultivation having been discontinued. It should also be remarked that so few have kept their Carniolans pure that purchasers who wish this race should use caution in their selection or else import their own breeding queens. There are many breeders of Italians from whom good stock can be obtained. Egyptian bees were tried some thirty years ago, but only to a very limited extent, and, as has been the case with Syrians and Palestines imported in 1880, and whose test was more prolonged and general, they were condemned as inferior in temper and wintering qualities to the races of bees already here, it not being thought that these points of inferiority were sufficiently balanced by their greater prolificness and their greater energy in honey collecting.

The Tunisians, for similar reasons and also because they are great collectors of propolis, never became popular, although a persistent attempt was made a few years since to create sale for them under the new name of "Punic bees," the undesirable qualities of the race having previously been made known, under the original name, by the author, who had tested them carefully for several years—a part of the time in Tunis.

Cyprians.—Bees of the race native to the Island of Cyprus have produced the largest yield of honey on record from a single colony in this country, 1,000 pounds in one season. Everyone who has fairly tested them admits their wonderful honey-gathering powers and their persevering courage in their labors even when the flowers are secreting honey but scantily. They winter well and defend their hives against robber bees and other enemies with greater energy than any other known race. When storing honey Cyprians fill the cells quite full before sealing, and thus the capping rests against the honey, present-

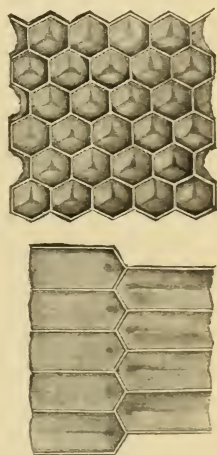
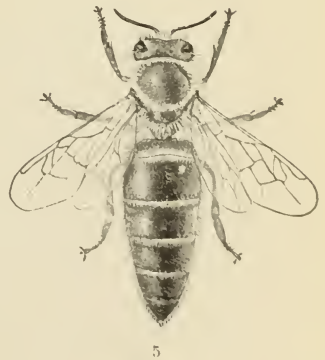

FIG. 4.—Worker-cells of common honey bee (*Apis mellifera*); natural size. (Original.)

ing a semitransparent or "watery" appearance, which is undesirable. They are extremely sensitive, hence easily angered by rough or bungling manipulators, and when once thoroughly aroused are very energetic in the use of their stings. These faults have caused a very general rejection of Cyprians, especially by those who produce comb honey. Even the producers of extracted honey do not seem to have learned how to manipulate Cyprians easily and without the use of much smoke, nor how much more rapidly they could free their extracting combs from Cyprian bees than from Italians. Nor have they seemed to count as of much importance the fact that Cyprians, unlike Italians and German or common bees, do not volunteer an attack when undisturbed; that they will, in fact, let one pass and re-pass their hives quite unmolested and even under such circumstances as would call forth a vigorous and very disagreeable protest from the other races just mentioned. It is to be regretted that there has been such a widespread rejection of a race having such important and well-established excellent qualities. It would be easier by selection in breeding to reduce the faults of this race than to bring any other cultivated race to their equal in the other desirable points.

Cyprians are smaller-bodied and more slender than bees of European races. The abdomen is also more pointed and shows, when the bees are purely bred, three light orange bands on the three segments nearest the thorax. The underside of the abdomen is even lighter orange colored nearly or quite to the tip. The postscutellum—the small lunule-like prominence on the thorax between the bases of the wings—is likewise orange colored instead of dull, as in European races. The rest of the thorax is covered with a russet-brown pubescence. Cyprians are the yellowest of the original races, and their bright colors and symmetrical forms render them attractive objects.

Italians.—Through the agency of the United States Department of Agriculture bees of this race were introduced direct from Italy in 1860. There had previously been repeated individual efforts to secure Italians bred in Germany, where the race had been introduced some years earlier, and a small number of queens had been landed here alive in the autumn of 1859, but most of these died the following winter and the few remaining alive seem not to have been multiplied as rapidly as those obtained in Italy by a purchasing agent of the Department of Agriculture and landed here early in 1860. Their good qualities were soon appreciated, and they had become well established and widely spread long before the Cyprians, imported twenty years later. For this reason, together with the fact that they cap their surplus combs whiter than some other races and because less skill is required in subduing and handling Italians, they have retained their popularity over bees which, though better honey gatherers, are more nervous under manipulation. Their golden-yellow color has also proved so attractive to many that the good qualities of more somber-hued races—gentler, better winterers, and better comb builders—have not received



HONEY BEES.

1. Worker, Carniolan variety of *Apis mellifera*—twice natural size.
2. Giant honey bee of East India (*Apis dorsata*), worker—twice natural size.
3. Giant honey bee of East India (*Apis dorsata*), drone—twice natural size.
4. Drone, Carniolan variety of *Apis mellifera*—twice natural size.
5. Queen, Carniolan variety of *Apis mellifera*—twice natural size.

due consideration. Italians are, however, certainly preferable to the common brown or black bees, for they show greater energy in gathering honey and in the defense of their hives against moth larvæ and robber bees, while at the same time they are gentler under manipulation than the blacks, though they do not winter as well in severe climates.

Italian workers nearly equal Carniolans in size, and show across the abdomen when the latter is distended with honey not less than three yellow bands, which approach more or less a reddish or dark leathery color. By selection in some instances, and in others by the introduction of Cyprian blood, Italians and Italian hybrids have recently been bred which show four or five yellow bands or which are even yellow to the tip of the abdomen. They are certainly pleasing to the eye, and in case due heed has been given to the vigor and working qualities of the stock selected when establishing the strain, no valid objection can be brought against them except the tendency they have to revert to the original type of Italians. This is due to the comparatively short time they have been bred, and with each season's selection will of course grow less.

Carniolans.—These, the gray bees from the elevated Alpine province of Carniola, Austria, are the gentlest of all races, and as, besides their other good qualities, they winter the best of any, it is not surprising to see that they have steadily grown in favor. Their sealed combs are exceedingly white, as they do not fill the cells so full that the honey touches the capping, and they gather little propolis, qualities highly appreciated by the producer of comb honey. They are quite prolific, and if kept in small hives, such as have been popularized of late in the United States, are somewhat more inclined to swarm than the other races introduced here. This tendency becomes more pronounced when they are taken into a country whose summers are hot, like ours, and their hives are not well shaded, as they have been bred for centuries, with only slight introduction of outside blood, in a climate where the summers are short and cool. Moreover, the practice in Carniola is to place the long, shallow hives used almost exclusively there, in beehouses and side by side, one above the other, with intervening air spaces, so that at most only the front ends are exposed to the sun. This management long continued has doubtless tended to develop and fix more or less permanently in this race certain characteristics which should be taken into account in their management elsewhere. With these precautions they do well in all parts of the United States. (See Plate I, figs. 1, 4, and 5.)

The Carniolan worker is readily recognized by its large form, less pointed abdomen, and general ashy gray coat, the abdominal segments especially presenting a ringed appearance on account of silvery white hairs which cover the posterior half of each of these segments. By crossing Carniolans with Italians or with Cyprians a yellow type with

silvery rings is produced, and by continued selection in breeding the gentle disposition of the Carniolans can be secured with the greater honey-gathering powers of Cyprians should these be employed in forming the new strain.

German, common black, or brown bees.—These bees are found commonly throughout our country from ocean to ocean, both wild and domesticated. Exactly when they were introduced from Europe is not known, but considerable evidence exists which shows that there were no hive bees (*Apis mellifera*) in this country for some time after the first colonies were established; also, it was not until near the close of the last century that they reached the Mississippi, and less than half a century has passed since the first were successfully landed on the Pacific Coast.

Many bee keepers, having more attractively colored and frequently better bees, are inclined to consider this race as possessing hardly any redeeming qualities, or at least to underrate these because accompanied by undesirable traits. While it is true that they have some serious faults, the latter are not so great as those of some other races. They have become thoroughly acclimated since their first importation, over two centuries ago, and besides possessing good wintering and comb-building qualities, they will, when the flow of honey is quite abundant, generally equal Italians in gathering. But the disposition which bees of this race have of flying toward one who approaches the apiary and stinging him, even though the hives have not been molested, their way of running excitedly over the combs and dropping in bunches when they are handled, besides stinging the backs of the operator's hands, unless the whole colony has first been thoroughly subdued and the bees induced to gorge themselves with honey, or are constantly deluged with smoke, are very annoying to the novice who undertakes to perform necessary manipulations with them, and may even so discourage and daunt him as to cause the neglect of work of great importance to the welfare of the colony. The easy discouragement of bees of this race when a sudden check in the flow of honey occurs is also a peculiarity which does not commend them. These things, tending to reduce profits, often dampen the beginner's enthusiasm before he has acquired the knowledge and skill necessary to make the work genuinely successful. He had therefore better choose either Italians or Carniolans, and use as breeders only queens that are known to have mated purely.

The common race shows considerable variation in its markings and qualities. The workers have a dull, rusty brown color, especially about the thorax. Some strains are however much darker than others and in general the drones are darker than the workers. In size workers, drones, and queens of this race are intermediate between the other European races and those from the Orient. The same care and skill applied in the selection of breeding stock would result in as great improvement in this as in any of the more attractive yellow races.

CHAPTER II.

KINDS OF BEES COMPOSING A COLONY—BEE PRODUCTS AND DESCRIPTION OF COMBS—DEVELOPMENT OF BROOD.

KINDS OF BEES IN A COLONY.

Each colony of bees in good condition at the opening of the season contains a laying queen and some 30,000 to 40,000 worker bees, or six to eight quarts by measurement. Besides this there should be four, five, or even more combs fairly stocked with developing brood, with a good supply of honey about it. Drones may also be present, even several hundred in number, although it is better to limit their production to selected hives, which in the main it is not difficult to accomplish.

Under normal conditions the queen lays all of the eggs which are deposited in the hive, being capable of depositing under favorable conditions as many as 4,000 in twenty-four hours. Ordinarily she mates but once, flying from the hive to meet the drone—the male bee—high in the air, when five to nine days old generally, although this time varies under different climatic conditions as well as with different races. Seminal fluid sufficient to impregnate the greater number of eggs she will deposit during the next two or three years (sometimes even four or five years) is stored at the time of mating in a sac—the spermatheca, opening into the oviduct or egg-passage (fig. 5, *s*). The queen seems

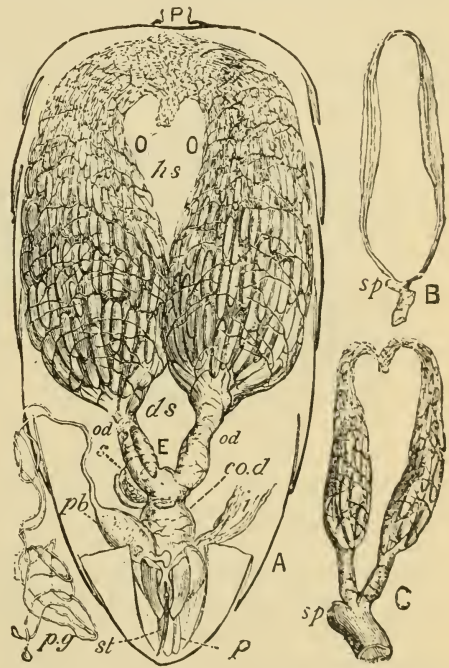

FIG. 5.—Ovaries of queen and workers: A, abdomen of queen—under side (magnified eight times); P, petiole; O, O, ovaries; *hs*, position filled by honey sac; *ds*, position through which digestive system passes; *od*, oviduct; *co.d*, common oviduct; E, egg-passing oviduct; *s*, spermatheca; *i*, intestine; *pb*, poison bag; *p.g.*, poison gland; *st*, sting; *p*, palpi. B, rudimentary ovaries of ordinary worker; *sp*, rudimentary spermatheca. C, partially developed ovaries of fertile worker; *sp*, rudimentary spermatheca. (From Cheshire.)

to be able to control this opening so as to fertilize eggs or not as she wills at the time of depositing them. If fertilized they develop into workers or queens according to the character of the food given, the size and shape of the cell, etc.; if unfertilized, into drones. The queen's life may extend over a period of four or five years, but three years is quite as long as any queen ought to be kept, unless a particularly valuable one for breeding purposes and not easy to replace. Indeed, if full advantage be taken of her laying powers it will rarely be found profitable to retain a queen longer than two years.

Upon the workers, which are undeveloped females, devolves all the labor of gathering honey, pollen, propolis, and bringing water, secreting wax, building combs, stopping up crevices in the hive, nursing the brood, and defending the hives. To enable them to do all this they are furnished with highly specialized organs. These will be more fully referred to in connection with the description of the products gathered and prepared by the workers.

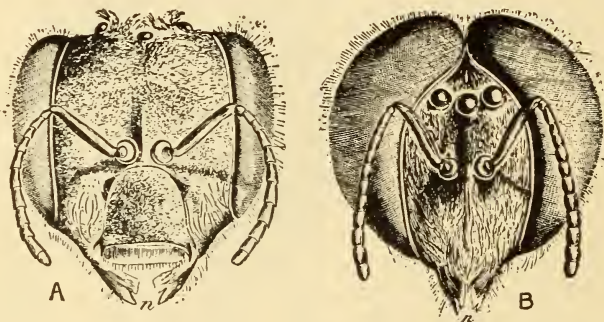

FIG. 6.—A, Head of queen, magnified ten times, showing smaller compound eyes at sides, and three ocelli on vertex of head; *n*, jaw notch. B, head of drone, magnified ten times, showing larger compound eyes at sides, with three ocelli between; *n*, jaw notch. (From Cheshire.)

The drones, aside from contributing somewhat to the general warmth of the hive necessary to the development of the brood, seem to have no other office but that connected with reproduction. In the wild state colonies of bees are widely separated, being located wherever the swarms chance to have found hollow trees or rock cavities, hence the production of many drones has been provided for, so young queens flying out to mate will not run too many risks from bird and insect enemies, storms, etc. Mating in the hive would result in too continuous in-and-in breeding, producing loss of vigor. As we find it arranged, the most vigorous are the most likely to reproduce their species.

At the time of the queen's mating there are in the hive neither eggs nor young larvæ from which to rear another queen; thus, should she be lost, no more fertilized eggs would be deposited, and the old workers gradually dying off without being replaced by young ones, the colony would become extinct in the course of a few months at most, or meet a

speedier fate through intruders, such as wax-moth larvæ, robber bees, wasps, etc., which its weakness would prevent its repelling longer; or cold is very likely to finish such a decimated colony, especially as the bees, because queenless, are uneasy and do not cluster compactly.

The loss of queens while flying out to mate is evidently one of the provisions in nature to prevent bees from too great multiplication, for were there no such checks they would soon become a pest in the land. On the other hand, the risk to the queen is not uselessly increased, for she mates but once during her life.

BEE PRODUCTS AND ORGANS USED IN THEIR PREPARATION.

Pollen and honey form the food of honey bees and their developing brood. Both of these are plant products which are only modified somewhat by the manipulation to which they are subjected by the bees and are then stored in waxen cells if not wanted for immediate use. Pollen, the fertilizing dust of flowers, is carried home by the bees in small pel-

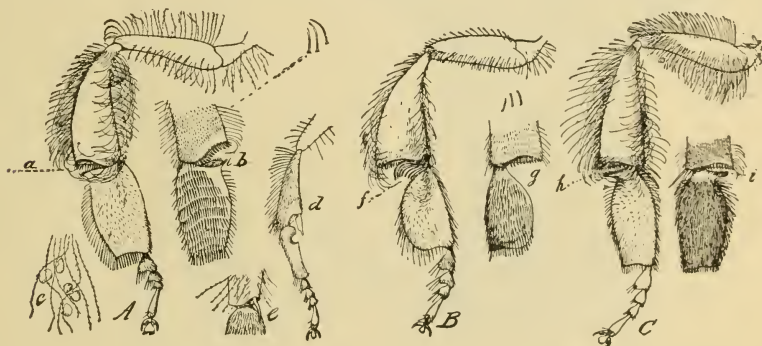

FIG. 7.—Modifications of the legs of different bees: A, *Apis*: a, wax pincer and outer view of hind leg; b, inner aspect of wax pincer and leg; c, compound hairs holding grains of pollen; d, anterior leg, showing antenna cleaner; e, spur on tibia of middle leg. B, *Melipona*: f, peculiar group of spines at apex of tibia of hind leg; g, inner aspect of wax pincer and first joint of tarsus. C, *Bombus*: h, wax pincer; i, inner view of same and first joint of tarsus—all enlarged. (From Insect Life.)

lets held in basket-like depressions on each of the hind legs. The hairs covering the whole surface of the bee's body are more or less serviceable in enabling the bee to collect pollen, but those on the under side of the abdomen are most likely to get well dusted, and the rows of hairs, nine in number, known as pollen brushes, located on the inner surface of the first tarsal joint (fig. 7, b), are then brought into use to brush out this pollen. When these brushes are filled with pollen the hind legs are crossed during flight and the pollen combed out by the spine-like hairs that fringe the posterior margin of the tibial joint—that above a in fig. 7. The outer surface of this joint is depressed, and this, with the rows of curved hairs on the anterior margin and the straighter ones just referred to forms a basket-like cavity known as the cor-

biculum or pollen basket, represented by the longest joints of the legs, A, B, and C, fig. 7. Into this the pollen falls, and with the middle pair of legs is tamped down for transportation to the hive. Having arrived there, the bee thrusts its hind legs into a cell located as near to the brood nest as may be, and loosening the pellets lets them fall into the bottom of the cell. The tibial spur (fig. 7, *e*) on each middle leg is, as Professor Cheshire has pointed out, probably of use in prying the pellets out. The latter are simply dropped into cells and left for some

other bee to pack down by kneading or pressing with its mandibles. Various colors—yellow, brown, red, slate, etc., according to the kinds of flowers from which gathered—frequently show in layers in the same cell. Often when partly filled with pollen the cell is then filled up with honey and sealed more or less hermetically with wax. The bees store the pollen, for convenience in feeding, above and at the sides of the brood and as near to it as possible, the comb on each side of the brood nest being generally well stored with it.

NECTAR AND HONEY.

The liquid secreted in the nectaries of flowers is usually quite thin, containing, when just gathered, a large percentage of water. Bees suck or lap it up from such flowers as they can

reach with their flexible, sucking tongue, 0.25 to 0.28 inch long. (Fig. 8, *l*.) This nectar is taken into the honey sac (Plate II, *h. s.*) located in the abdomen, for transportation to the hive. It is possible that part of the water is eliminated by the gatherers before they reach the hive. A Russian bee keeper, M. Nassanoff, while dissecting a worker, discovered

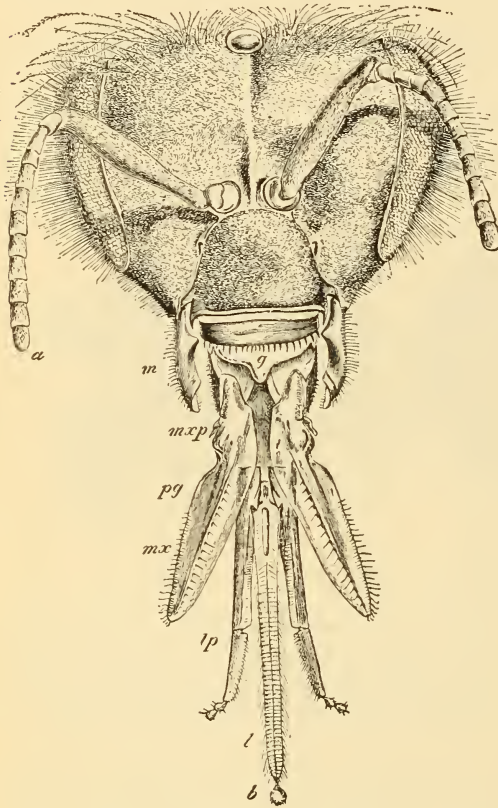
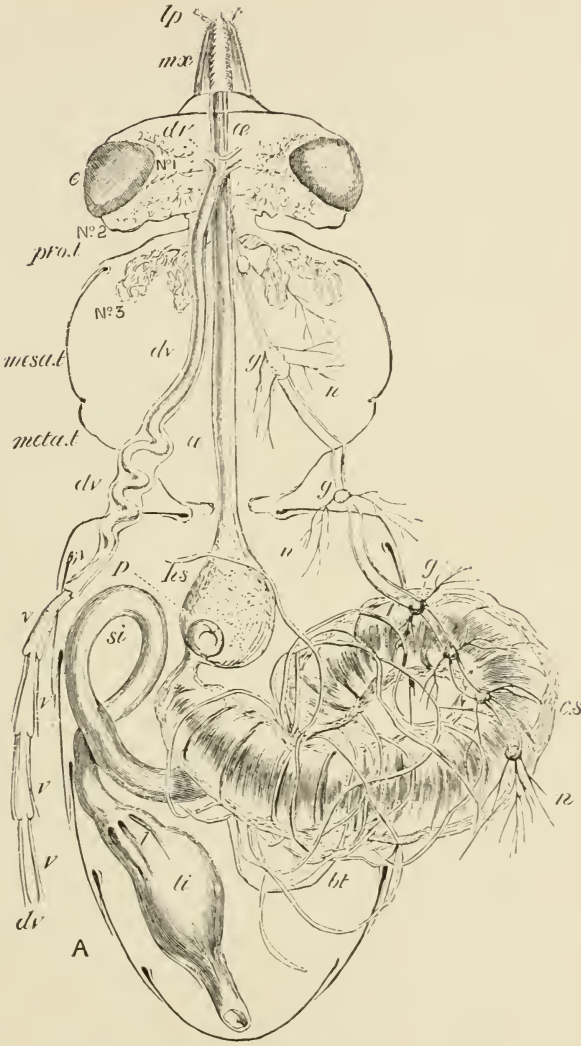

FIG. 8.—Head and tongue of *Apis mellifera* worker (magnified twelve times). *a*, Antenna, or feeler; *m*, mandibula, or outer jaw; *g*, gum flap, or epipharynx; *mxp*, maxillary palpus; *pg*, paraglossa; *mx*, maxilla, or inner jaw; *lp*, labial palpus; *l*, ligula, or tongue; *b*, bouton, or spoon of the same. (Reduced from Cheshire.)



DIGESTIVE SYSTEM OF BEE (magnified ten times).

A, Horizontal section of body: *lp*, labial palpus; *mx*, maxilla; *e*, eye; *dv*, *dv*, dorsal vessel; *v*, ventricles of the same; No. 1, No. 2, No. 3, salivary gland systems. 1, 2, 3; *α*, oesophagus; *pro.t*, prothorax; *mesa.t*, mesothorax; *meta.t*, metathorax; *g. g.*, ganglia of chief nerve chain; *n*, nerves; *hs*, honey sac; *p*, petaloid stopper of honey sac or stomach mouth; *c.s.*, chyle stomach; *bt*, biliary or Malpighian vessels; *si*, small intestine; *l*, lamellæ or gland plates of colon; *li*, large intestine.

between the fifth and sixth abdominal segments a small canal, to which he attributed an excretory function, and Zoubareff, having noticed bees ejecting a watery substance while returning from the fields, suggested that this gland probably served to separate a portion of the water from the nectar, the liquid deposited in the cells appearing to contain less of it than that just secreted by the flowers. However this may be, evaporation takes place rapidly in the heat of the hive after the nectar or thin honey has been stored, as it is temporarily, in open cells. Besides being thin, the nectar has at first a raw, rank taste, generally the flavor and odor peculiar to the plant from which gathered, and these are frequently far from agreeable. To make from this raw product the healthful and delicious table luxury which honey constitutes—"fit food for the gods"—is another of the functions peculiar to the worker bee. The first step is the stationing of workers in lines near the hive entrances. These, by incessant buzzing of their wings, drive currents of air into and out of the hive and over the comb surfaces. If the hand be held before the entrance at such a time a strong current of warm air may be felt coming out. The loud buzzing heard at night during the summer time is due to the wings of workers engaged chiefly in ripening nectar. Instead of being at rest, as many suppose, the busy workers are caring for the last lot of gathered nectar and making room for further accessions. This may go on far into the night, or even all night, to a greater or less extent, the loudness and activity being proportionate to the amount and thinness of the liquid. Frequently the ripening honey is removed from one set of cells and placed in others. This may be to gain the use of certain combs for the queen, or possibly it is merely incidental to the manipulation the bees wish to give it. When, finally, the process has been completed, it is found that the water content has usually been reduced to 10 or 12 per cent, and that the disagreeable odors and flavors, probably due to volatile oils, have also been driven off in a great measure, if not wholly, by the heat of the hive, largely generated by the bees. During the manipulation an antiseptic—formic acid—secreted by glands in the head of the bee, and it is also possible other glandular secretions, have been added. The finished product is stored in waxen cells above and around the brood nest and the main cluster of bees, as far from the entrance as it can be and still be near to the brood and bees. The work of sealing with waxen caps then goes forward rapidly, the covering being more or less porous.

Each kind of honey has its distinctive flavor and aroma, derived, as already indicated, mainly from the particular blossoms by which it was secreted, but modified and softened by the manipulation given it in the hives. When the secretion is abundant in a flower having a short or open corolla, hence one from which the bees find it easy to obtain the honey, they will confine their visits to that kind if the latter is present in sufficient numbers. Thus it is that linden, white clover, buckwheat,

white sage, mesquite, sourwood, aster, tulip tree, mangrove, orange, and other kinds of honey may be harvested separately, and each be readily recognizable by its color, flavor, consistency, and aroma. When, however, no great honey yielder is present in large quantity and the source is miscellaneous, all manner of combinations of qualities may exist, introducing great and often agreeable variety. Thus the medicinal qualities and the food value of different kinds of honey differ as greatly as do their prices on the market.

PROPOLIS.

This substance, commonly known as "bee glue," is obtained by the bees from the buds and crevices of trees, and is carried to the hives in the corbicula or basket-like cavities on the outside of the tibial joints of the workers' hind legs, the same as they carry pollen. The workers with their mandibles scrape together and bite off the particles of propolis, and with the front and middle legs pass them back to the baskets, where the middle legs and feet are used to tamp them down. The pellets can be readily distinguished from those of pollen, the latter being dull and granular in appearance, while the freshly gathered propolis is compact and shiny. This resinous material, which becomes hard soon after it is gathered, is at first quite sticky, and the bee bringing it requires aid in unloading. Another worker takes hold of the mass with its jaws, and by united exertion they get it out of the pocket, though often by piecemeal and in long threads. It is not stored in cells, but is used at once to stop up crevices in the hives and to varnish the whole interior surface, as well as to glue movable portions fast, also in strengthening the combs at their attachments, and if the latter are designed exclusively for honey, and especially if not filled at once, the edges of their completed cells receive a thin coating of propolis, which adds considerably to their strength. The bees often make the flight hole smaller by filling a part of it with masses of propolis, sometimes mixed with old wax. Carniolans gather the least and Tunisians the most propolis of any of the different races. On this account the former are better suited than the latter to the production of fancy white comb honey.

BEE POISON AND THE STING.

The worker and the queen are supplied with another organ which is of great importance to them, namely, the sting; for without this the hard-earned stores of the hive would soon be a prey to all manner of marauders, and the queen would be deprived of an organ of occasional use to her in dispatching rivals, and of daily use to her during the working season in the deposition of eggs. The darts work independently and alternately, and are connected at the base with the poison sac, without whose powerful contents such a tiny weapon would be wholly ineffective. Poison glands pour an acid secretion—largely formic acid—into this sac, whence it is conveyed to the tip of the sting

along the groove or canal formed by the junction of the sheath and the darts. The sting being but an ovipositor modified to serve also another purpose in addition to oviposition, in the perfect female (the queen) its main use is in placing the eggs in their proper position in the bottoms of the cells.

Formic acid is known to have considerable antiseptic properties. Chemical tests show its presence in well-ripened honey, but not in freshly gathered nectar. The natural conclusion is that it has been added by the bees to assist in the preservation of the honey. In what manner it is supplied has frequently been questioned. Tests applied to the blood of the bee show its presence there, and the secretions of the head glands show still larger quantities. It is therefore reasonable to suppose that these glands, as well as the poison glands themselves, secrete formic acid, and that the honey receives its portion from the former, the head glands, upon being disgorged from the honey-sac or during the manipulation to which it is subjected in the hive.

WATER.

During cold or cool weather much condensation of moisture takes place in wooden hives as these are usually arranged. The water, collecting in drops on the interior walls of the hive and on the cold, sealed honey, often trickles down over the cluster of bees, to their great injury. It has been claimed that when brood rearing begins this condensed moisture will be utilized in the preparation of brood food. Very possibly it may, yet its use is probably detrimental, since it is charged with waste products of the hive—those of respiration, etc. In its absence the water contained in the honey, if the latter has not granulated, seems to be sufficient. Later, however, when no condensation takes place in the hive and the greater number of developing larvæ require considerable supplies of water in their food, special trips are made to brooks and pools for it, and dew is often gathered from leaves.

SILK.

The larval bee produces a small amount of silk from glands in its head. The pupal cell is partially lined with this. Later, as the bee develops, there being no further use for the glands, they become atrophied.

WAX.

The light-colored pellets which are carried into the hive on the hind legs of the workers, and which have been described as pollen, are often mistaken for wax. The fact is, wax is not gathered in the form in which we see it, except in rare instances, when, bits of comb having been left about, small quantities will be loaded up and taken in as pellets on the legs. Ordinarily it comes into the hive in the shape of honey and is transformed by the workers within their own bodies into wax. This production is wholly confined to the workers, for although

the queen has wax plates on the underside of the abdomen and wax glands beneath them, yet both are less developed than in the workers and are never used. The wax plates of the worker overlying the secreting glands are well shown in fig. 9, those of the queen and of the related genera, *Bombus* and *Melipona*, being shown for comparison. During wax secretion, that is, when combs are being built or honey cells sealed over, a high temperature is maintained in the hive, and many workers may be seen to have small scales of wax protruding from between the segments of the abdomen on the underside. The molds or plates, eight in number, in which the scales appear are concealed by the overlapping of the abdominal segments, but when exposed to view (fig. 9, *a*) are seen to be five-sided depressions lined with a transparent membrane. The wax glands themselves are beneath this membrane, and through it the wax comes in a liquid form. As the scales harden they are pushed out by the addition of wax beneath.

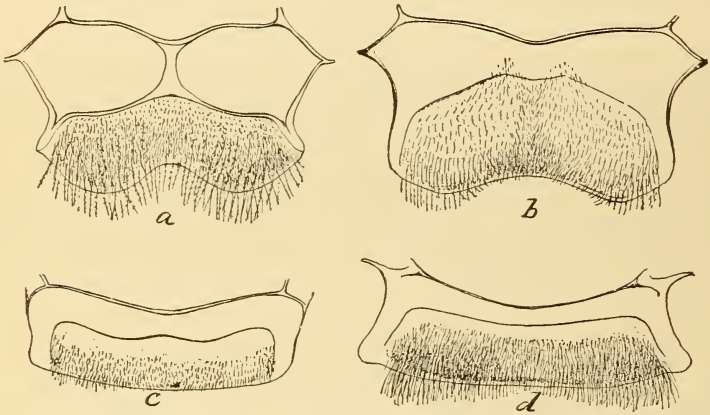

FIG. 9.—Wax disks of social bees: *a*, *Apis mellifera* worker; *b*, *A. mellifera* queen; *c*, *Melipona* worker; *d*, *Bombus* worker—all enlarged. (From *Insect Life*.)

The bees pluck them out with neat pincers (fig. 7, *a* and *b*) formed by the articulation of the hind tibiae with the adjacent tarsal joints, pass them forward to the mandibles, and mold them into the shape of hexagonal cells, meanwhile warming and moistening them with the secretions of the head glands to render the wax more pliable.

COMBS.

Wax is fashioned by the workers into cells of various sizes and shapes, according to the use to be made of them. The most regular in shape and size are the cells designed for brood (fig. 4). These combs in which workers are bred show nearly 29 cells on a square inch of surface, the combs being seven-eighths inch thick and the cells generally quite regular hexagons in outline. Drone cells are larger, there being but 18 of them to the square inch of surface, and the comb is $1\frac{1}{4}$ inches thick.

The cells of combs designed only for honey are frequently more irregular in shape, generally curve upward somewhat, and are often deepened as the honey is stored in them, so that these combs sometimes reach a thickness of 2 or 3 inches.

The cells in which queens are bred bear in size and shape some resemblance to a ground or pea nut. They are often irregular in form, being sometimes curved, or short and thick, according to the space below their point of attachment, which is most frequently the lower edge or the side edge of a comb, or sometimes a mere projection or angularity in the general surface of a comb. Queen cells open downward instead of being built horizontally like drone and worker cells (figs. 62 and 63).

Into the material used in constructing brood combs bees often incorporate bits of wax and fiber-like gnawings of cocoons from old combs in which brood has been reared, and if given cappings or trimmings of combs they will work them all over and utilize most of the material.

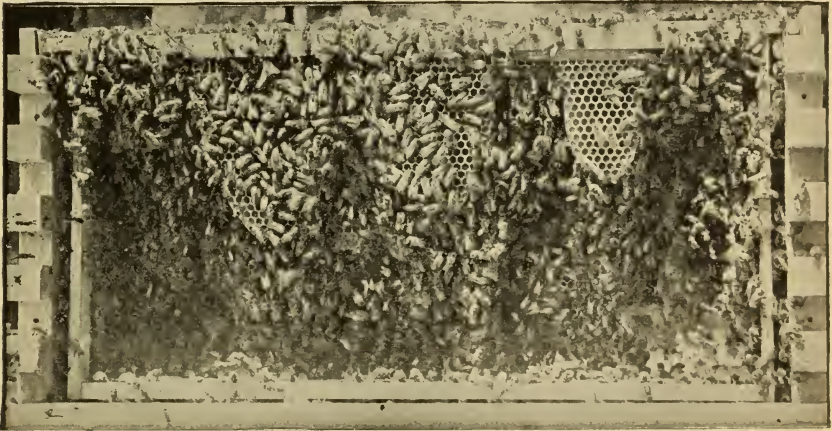

FIG. 10.—Comb building—side of hive removed. (Original.)

Also when the bees have abundant supplies of pollen much of this is incorporated into the material of brood combs, thus saving the costlier substance—wax. Such combs show at once by their brownish or straw color, even when first constructed, that they are not made of wax alone. It will readily be seen from the above that the quantity of honey consumed by the bees in producing a pound of comb must vary greatly, for if the comb is designed for surplus honey it will be made of newly secreted wax, while if for brood other material will, as just stated, replace a portion of the wax. The amount of honey coming in varies from day to day, and it is difficult to estimate how much is consumed in feeding and keeping warm the brood; moreover, a high temperature is required in the hive to facilitate the secretion and working of wax, necessitating, of course, extra food consumption when the out-

side temperature is low. Accordingly estimates as to the amount of honey required to produce 1 pound of comb range from 5 pounds to 25 pounds. More accurate experiments are needed in this direction before anything positive can be stated. Until then 18 to 20 pounds might be looked upon as nearest the correct figure for white surplus combs, and half as much for dull straw-colored or brownish combs built for brood rearing.

DEVELOPMENT OF BROOD.

Ordinarily the winter cluster in a hive of bees occupies the more central combs, four or five in number. Near the middle of this cluster the queen deposits the first eggs of the season (which are fertilized eggs) in the small-sized or worker cells. Under favorable circumstances, that is, in a strong colony amply protected against inclement weather, this deposition usually occurs in January, though in a very mild climate some brood is generally present during every month of the year, and the cessation of egg-laying is very short. The eggs hatch on the third day after deposition into minute white larvæ, to which the workers supply food in abundance. The composition of this food has been the subject of much attention and more theorizing. It may be considered as pretty certain that during the first three days of the life of the larva its food is a secretion from glands located in the heads of the adult workers—a sort of bee milk, to which, after the third day, honey is added in the case of the worker larvæ, and honey and pollen in the case of drone larvæ. As this weaning proceeds both worker and drone larvæ receive pollen, and in constantly increasing proportions, in place of the secretion. But this rich albuminous substance is continued to the queen larvæ throughout their whole period of feeding; moreover, the quantity of this food supplied to each queen larva is apparently superabundant, for after it ceases to feed quite a mass of the food somewhat dried out will be found in the bottom of the cell from which a well-developed queen has issued. After assuming the pupa form the young queen is attached to this food by means of the tip of the abdomen, and it very likely continues for some time to receive nourishment from the mass.

The following table shows approximately the time occupied in the development of worker, drone, and queen:

	Egg.	Larva.	Pupa.	From deposition of egg to imago.
	<i>Days.</i>	<i>Days.</i>	<i>Days.</i>	<i>Days.</i>
Queen	3	5½	7	15½
Worker	3	5	13	21
Drone	3	6	15	24

The original circles of brood are gradually increased by the deposition of eggs in the cells next outside those already occupied, and circles are soon begun in the adjoining combs. In this way the space occupied by

the developing bees is gradually increased, while preserving the general spherical shape of the brood nest thus formed, which, however, the shape of the hive often modifies somewhat. As already mentioned, each circle of brood has rows of pollen cells about it, chiefly above and at the sides, and the combs on either side contiguous to the brood are usually well packed with pollen. Outside of the pollen most of the honey on hand is stored. Thus (fig. 11) a cross section made in any direction through the middle of a hive in normal condition at the opening of the active season should show this relative arrangement of brood, pollen, and honey, which economizes most the heat of the hive and the labors of the nurse bees, favoring in this way the rapid increase of the population.

THE WORKER.

The worker larvæ are fed five days, and then the cell is given by the adult bees a covering which is quite porous by reason of numerous

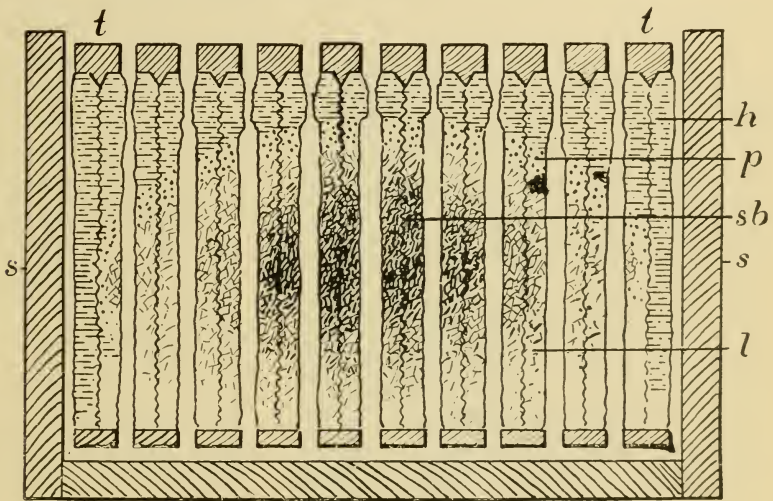

FIG. 11.—Cross section of brood apartment: *s, s*, sides of hive; *t, t*, top-bars of frames; *h, p, l, sb*, combs containing (*h*) honey, (*p*) pollen, (*l*) larvæ and eggs, and (*sb*) sealed brood. (Original.)

pollen grains incorporated into its mass, this openness of texture being necessary to give the developing bee air to breathe. The larva strengthens this capping by a loose webwork of silk within, extending down the side but slightly and attached at its edges to the last skin cast by the molting larva. This skin, extremely delicate and pressed closely against the inside of the cell, forms the lining of its sides and bottom. In about twelve days after sealing, that is, twenty-one days from the time the egg was deposited, the imago, or perfect bee, bites its way through the brown covering.

In the course of a couple of days it takes up the work of a nurse, and in a week to ten days may appear at the entrance on pleasant days, taking, however, but short flights for exercise, as ordinary field work is

not undertaken until it has passed about two weeks in the care of brood. The worker then takes up also wax secretion, if honey is to be capped over or combs built, although old bees can and do to a certain extent engage in wax production.

THE DRONE.

Eggs left unfertilized produce drones and require twenty-four days from the time they are deposited until the perfect insect appears. They are normally deposited in the larger-sized horizontal cells, and when the latter are sealed, the capping is more convex as well as lighter-colored than that of worker brood, which is brown and nearly flat.

The fact that drones develop from unfertilized eggs is to be noted as having an important practical bearing in connection with the introduction of new strains of a given race or of new races of bees into an apiary. From a single choice home-bred or imported mother, young queens of undoubted purity of blood may be reared for all of the colonies of the apiary, and since the mating of these young queens does not affect their drone progeny, thereafter only drones of the desired strain or race and pure in blood will be produced, rendering, therefore, the pure mating of future rearings fairly certain if other bees are not numerous within a mile or two. Eventually also all of the colonies will be changed to the new race and without admixture of impure blood, provided always that the young queens be reared from mothers of pure blood mated to drones of equal purity.

CHAPTER III.

QUIETING AND MANIPULATING BEES.

The demeanor of bees toward an individual depends largely upon his bearing and treatment of them. Langstroth, in his excellent treatise, *Langstroth on the Honey Bee* (p. 193, revised edition), says:

Let all your motions about your hives be gentle and slow; never crush or injure the bees; acquaint yourself fully with the principles of management, and you will find you have little more reason to dread the sting of a bee than the horns of a favorite cow or the heels of your faithful horse.

Most bee manipulators, however, grow somewhat indifferent to stings, since in time they become so inoculated with the poison of the bee that the pain of the sting is less severe and the swelling slight. *But to avoid the stings is, with some of the races more recently introduced into this country, simply a question of care in manipulation and a free use of smoke.* It is not meant that the bees should be stupefied with smoke, but merely alarmed and subjugated, and whenever they show any disposition to act on the offensive recourse is to be had to smoke. It is not necessary that the smoke should be from a particular source, but that from certain substances, as tobacco, subjugates them more quickly,



FIG. 12.—Use of veil and bee smoker. (Original.)

while burning puffball stupefies them for the time. There are some objections to these substances which do not apply to wood, either partially decayed or sound, and as the latter when in a good smoker holds fire best and is very effective, it is advisable to keep a good supply at hand. Seasoned hickory or hard maple are best, though beech, soft

maple, etc., are good. The most improved bellows smokers, when supplied with such fuel sawed 5 or 6 inches long and split into bits a half inch or less in size, will burn all day and be ready at any time to give a good volume of blue smoke, by which bees of most of the races now cultivated in this country are subdued at once.

With Italian or black bees a puff or two of smoke should be given at the hive entrance and the cover and honey board, or quilt, removed slowly and carefully, smoke being driven in as soon as the least opening is made and the volume increased enough to keep down all bees as fast as the covering is removed. The smoker may then be placed on the wind-

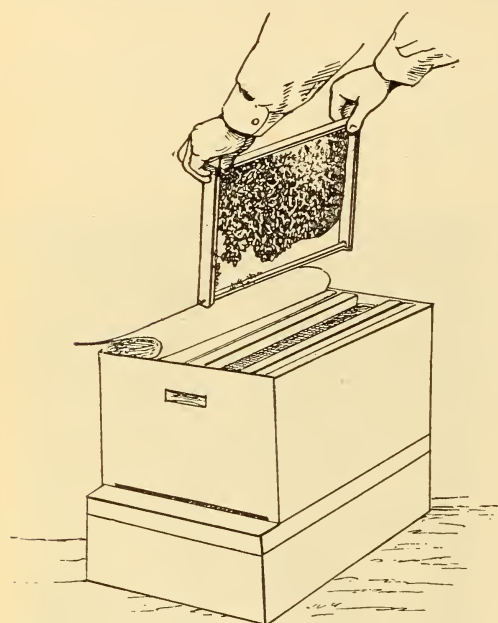

FIG. 13.—Manipulation—removing comb from hive. (Original.)

ward side of the hive to allow the fumes to pass over the top and toward the operator. The frames may then be gently pried loose and lifted out carefully, without crushing a bee if it can be avoided. Crushing bees fills the air with the odor of poison, which irritates the bees. So also when one bee is provoked to sting others follow because of the odor of poison.

Too much smoke will often render certain manipulations difficult; for example, when queens are to be sought out, or nuclei or artificial swarms made, volumes of smoke blown in between the combs will drive the bees from them so that they will cluster in clumps on the bottoms of the frames or in the corners of the hives. A little observation and judgment will enable one to know when the bees need smoke and how much of it to prevent any outbreak on their part, which it is always best to forestall rather than be obliged to quell after it is fully under way.

The frame hive as now made—with metal rabbets and arrangements for surplus honey, and quilts instead of honey boards—reduces propolization to a minimum and renders the danger of irritating the bees by jarring when manipulating much less. As a prerequisite to rapid and safe manipulation *perfectly straight combs are necessary.*

With the common or black bees it is never safe to do without the veil as a protection to the face, and with these bees it will also be very diffi-

cult to avoid stings on the hands unless considerable smoke has been driven into the entrance beforehand and time has been given the bees to get well filled with honey before the hive is opened; even then frequent recourse to smoke will generally be necessary. Blacks are by far the most troublesome of all races about flying from their hive entrances to sting in an unprovoked manner. Next to these are the crosses containing the blood of the blacks. Italians have much less of this disposition, and Carniolans and Cyprians rarely, the latter almost never, fly from their hive entrances to attack unless their hives have been disturbed. *Pure Cyprians* can generally be handled without the use of the bee veil by skillful bee

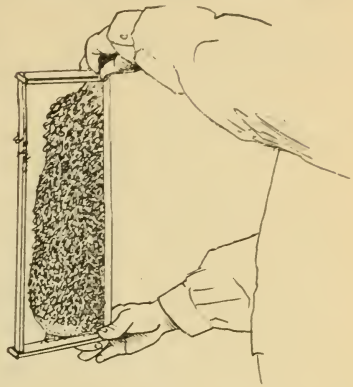

FIG. 14.—Manipulation—tilting to bring reverse side of comb in view. (Original.)

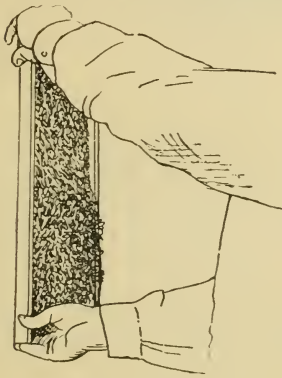

FIG. 15.—Manipulation—reverse side of comb brought to view. (Original.)

manipulators who understand the qualities of the race. Much of the work among pure Italians can be done without a veil after one has gained experience in manipulation. During four years' residence in Carniola the writer, manipulating annually several hundred colonies of bees, never had occasion to employ a bee veil. If no bees but gray Carniolans of pure blood are in the apiary and some smoke is used a veil will never be necessary. They may be handled in all kinds of weather, early and late, even during the night, yet with but a small part of the risk which attends the manipulation of other races. Nor will it be necessary to deluge them with smoke from

time to time, as one is obliged to do with blacks. To dispense entirely with the bee veil is a more important consideration, especially to the professional beemaster, than is at first apparent to the inexperienced. Its use injures the eyesight seriously, especially where one is obliged to strain his eyes for hours to see eggs, larvæ, etc., in the cells, to hunt out queens and queen cells, and adjust frames. Besides this, the hindrance to rapid work which the veil causes, as well as the great discomfort in wearing it for hours during hot weather, are considerations worth weighing.



FIG. 16.—Manipulation—examining reverse side of comb. (Original.)

To recapitulate: To secure easy, rapid, and safe manipulation accurately made hives, with the frames, if hanging, arranged to rest on folded metal rabbets, and the combs perfectly straight, are essential. It is equally important also that some one of the gentler races be kept.

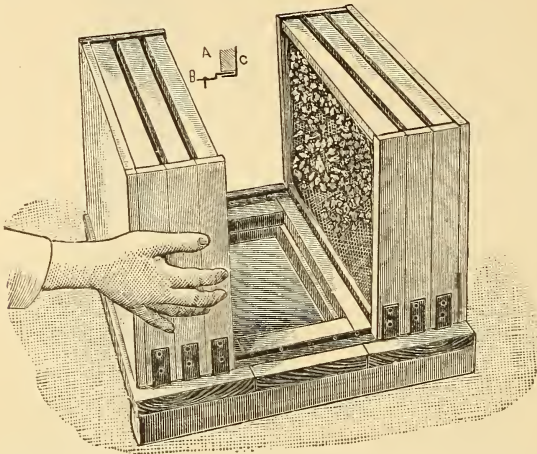

FIG. 17.—Quinby closed-end frames. (From A B C of Bee Culture.)

Furthermore, a good bee smoker fed with dry fuel is necessary, while the bee escape to clear supers without manipulation of combs is a great help. Quilts, queen excluders, and bee escapes reduce the amount of manipulation required, and at the same time facilitate what is absolutely necessary.

In general, the best time to manipulate hives is when most of the bees are busy in the fields. The young bees left at home are most easily controlled and the old ones returning are generally laden.

CHAPTER IV.

ESTABLISHING AN APIARY: TIME—SELECTING HIVES OF BEES— MOVING BEES—SELECTION OF SITE.

Spring is the best season to establish an apiary, especially for a person unacquainted with the practical care of bees. Colonies in good condition procured then are more easily kept in order by the novice than if purchased in the fall. Mistakes in management may possibly be remedied before the season closes, and by the time it is necessary to prepare for the winter the learner will have gained a certain amount of practical knowledge of the nature and requirements of the bees. If the start be made late in the season mistakes, if they occur, may result fatally before the proper remedy can be applied.

The beginner had better obtain his start by purchasing one or two colonies of pure Italian or Carniolan bees in accurately made frame hives and in first-class condition. These he should get from some bee-master of repute near his own place, if possible, in order to avoid expressage and possible damage through long confinement or numerous transfers. The cost per colony may be \$6 to \$8; yet bees at this price will generally be found much cheaper in the end, for, though common bees in box hives may frequently be obtained for half or even less than half as much, the cost, when finally transferred into frame hives, fitted up with straight combs, and the common queens replaced by Italians or Carniolans, will not be less. The possession of a colony already in prime working order gives the novice a standard with which to compare all others and often enables him to avoid costly experiments. Another plan, also commendable, is to agree with some neighboring bee keeper to deliver as many first swarms on the day they issue as are wanted. These will give the right start if placed as soon as received in hives with foundation starters and the frames properly spaced—1 $\frac{3}{4}$ inches from center to center, it being understood that the swarms are early and prime ones, with vigorous queens. Only those issuing from colonies that have swarmed the year before or from such as were themselves second swarms of the previous year should be accepted. Swarms from these will have queens not over one year old. It is better to have queens of the current year's raising, but these can only be obtained by taking the second or third swarms from a given hive, which come later and are smaller, or by substituting young queens for those which come with the swarms.

SELECTION OF STOCKS.

The relative strength of different stocks may be determined by watching the flight of the bees. The playing of the young bees in front of the hive is apt to deceive one. This lasts but twenty minutes

or so, but a weak stock compared then with a strong one whose young bees are not flying might be regarded as very populous. The young bees sporting in front of the hive may be known by their light, fuzzy appearance, and by the fact that as they take wing to leave the hive they turn their heads toward the entrance and sail about it in semicircles, frequently alighting on the flight board and taking wing again. They are thus marking the location of the hive so as to be able to return to it, for an attempt to enter another hive might result fatally to them. They finally fly away in constantly widening circles. Field workers used to the location fly in a direct line away from the hive. When the young bees return they do not alight at once as do the field workers laden with honey, but generally hover about the entrance until certain they have reached the right hive. Having noted by their flight which stocks seem to have the most bees, a closer examination can be made by blowing a little smoke of any sort into the entrances and tipping the hives back, if they stand on loose bottom boards. When not so constructed the examination must, of course, be made by removing the top covering, or if the combs are built in frames, some of these.

In addition to the strength of the colony, the number of combs containing brood, straightness, kind and age of combs, amount of honey on hand, the cleanliness and healthfulness of the colony are points upon which full information is desirable. In April a good colony located in a central latitude ought to have brood in five or six combs; yet as ordinarily wintered it will be difficult to find colonies having at this time more than three or four combs containing brood. The combs should be straight, so that if in an old-fashioned box hive they can be cut out and fitted without great waste into frames, and if the hive is a frame one it is absolutely necessary to have combs straight and built wholly within the frames in order that the latter may be readily removed and returned to the hive. The less drone comb the better. There will always be enough, an area half the size of a man's hand being quite sufficient for each hive. The larger size of the drone cells and greater thickness of the combs ($1\frac{1}{4}$ inches) will make it readily recognizable. If over one-eighth of the surface is drone comb the colony should be rejected. If the combs are so old as to be nearly black and to show cell walls much thickened they are very objectionable. There should be several pounds of sealed honey in each hive in early spring. Other things being equal, those stocks which come through the winter with 20 pounds or so of sealed honey in the combs will develop much faster than those having just enough to last them until they gather fresh honey rapidly enough to supply their daily needs. The presence of an abundance gives the bees courage. They do not fear to draw upon their stores to supply the young that are fast developing. The combs filled with honey part with their heat only slowly when the outside temperature falls, and there is thus less danger of a check in the development of the brood through too low temperature in the hive.

If the surfaces of the combs, the frames, or the inner walls of the hive are spotted with a brown, crumbly looking substance, it is an evidence that the bees have had diarrhea during the winter or spring, and if they have been badly affected not only will the combs and the whole interior of the hive be soiled, the former perhaps so as to be rendered almost worthless, but the bees will lack vitality, and will soon dwindle in numbers, not being able to survive the first arduous labors of the opening of the season. It is not always easy to determine whether a stock in a box hive is affected with foul brood or not, for the odor of decaying brood is not of itself sufficient to warrant such a conclusion, although it is well to reject any hive having any putrid odor about it. The natural odor of the hive, produced as it is largely by honey, wax, pollen, and propolis, is not unpleasant to most people, so that the presence of any disagreeable odor should arouse suspicion.

If larvae that have turned black are seen in the cells, and the capping of the sealed brood is sunken and in some instances perforated, showing brown and ropy contents in the bottoms of the cells, and the putrid odor is present, the existence of foul brood (*Bacillus alvei* Cheshire) is pretty certain. This is a scourge much to be dreaded. Not only should no hives or colonies be purchased from the same apiary, but none in the vicinity of an apiary so affected.



FIG. 18.—Box hive prepared for transportation. (Original.)

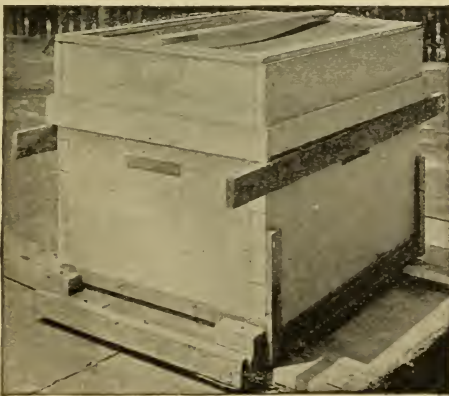

FIG. 19.—Frame hive prepared for transportation. (Orig.)

In moving bees the box hives should be turned bottom upward, the bees driven back by blowing a little smoke on them, and a few loose rolls of rags laid across the lower edges of the combs in such a manner that a piece of sheeting, sacking, or preferably cheese cloth or other open material may be tied over the whole lower end and drawn tightly, so as to press the rolls against the combs and hold them in place. It is even well to tack strips of lath outside of the covering, so placed that they will cross the rolls of rags and press the latter more firmly against the lower edges of the combs. Strips may also be tacked around the

MOVING BEES.

lower edges of the hive to hold the cloth in place, or it may be fastened by winding with strong cord. The bees should be thus prepared as late in the day as possible, care being taken that none escape, and at dusk stood bottom upward in a spring conveyance or on straw or hay several inches deep in the box of a wagon, with straw packed between and around the hives. It is advisable to drive slowly, avoiding ruts as much as possible. By turning the hives bottom upward the weight of the combs rests on their points of attachment, and since in such hives the combs are not always attached well down the sides danger of breakage is lessened, especially when the rolls of cloth are pressed against the edges of the combs. If the bees are in frame hives, the frames of which have not been disturbed recently, it is likely that, with care in



FIG. 20.—An apiary in Florida. (Reproduced from photograph.)

driving, the combs will not get displaced. If necessary to use a sheet or cloth to give ventilation, it should be tied over the top and the hive placed in the wagon in the same position it occupied on the stand, lest the combs, not being attached all the way down, should fall to one side or the other. Except during quite warm weather and for long trips it may not be necessary to adopt all the precautions here indicated, although in case bees are to be transported on long journeys by rail or water far more careful preparation is even necessary.

SELECTION OF SITE.

The apiary should be located where no surface water will collect during heavy storms, yet the ground should not be very uneven, but rather a gentle slope. In the colder portions of the United States a southeastern exposure is decidedly preferable, though in the South the slope of the site is less important to the welfare of the bees; a direct southern

or southwestern exposure, however, will be found extremely uncomfortable at times both for the operator and for his bees. A windbreak, such as a board fence, a hedge, or a row of evergreens on the north and west, is advisable as a protection against sharp winds in winter and early spring, which keep many bees from reaching their hives even when near the entrances. Some shade is desirable, yet such density as to produce dampness is extremely detrimental. In moist elevated regions, which are of course cool, no shade will be needed, except temporarily for newly hived swarms. Tall trees are objectionable in or near the apiary, because swarms are likely to cluster so high as to render their capture difficult and dangerous. Some of the self-livers or nonswarming devices now offered for sale may with improvement yet accomplish the end in view, but heretofore clipping one wing of each laying queen



FIG. 21.—An apiary in California. (Reproduced from photograph.)

and using all precautions to prevent after-swarms, making artificial swarms, selection in breeding, or any other means known to limit swarming, have not sufficed to prevent the occasional issuance of a swarm with a queen having wings. Therefore it is advisable to have the apiary located under or near low trees, where the hives can be readily seen from the house. Carniolan, Italian, and Cyprian bees give less trouble to passers-by or to live stock than do the ordinary brown or German bees, or hybrids of these races, yet whatever race be kept, it is best to have the apiary as secluded as the necessary or desirable conditions will permit.

The frontispiece and figures 20, 21, and 75, taken from photographs of apiaries located in different parts of the country, give a fair idea of sites actually occupied and the arrangement of hives.

CHAPTER V.

HIVES AND IMPLEMENTS.

The safest and best rule in making or selecting hives and implements for the apiary is, *have them simple and accurate in construction*. A plain box with frames and as few other loose parts as possible will yield in the hands of a skillful beemaster far better results than the most elaborately constructed bee palace manipulated by one who does not understand the nature and requirements of bees; in fact, the most experienced generally prefer the former. The important point to decide in connection with any proposed modification or adjunct of the hive is whether its adoption will more than compensate for the resultant loss of simplicity. While zealously endeavoring to preserve simplicity of construction, however, complete adaptability to the purpose designed must be kept in view, and should not be sacrificed because of a slight added expense. The bee keeper needs but few implements. With even a limited number of hives, a smoker, a wax extractor, and a few queen-introducing cages are the most necessary, and one or two bee veils had better be added to the equipment, the total cost of which need not exceed \$5 to \$6. If the intention be to produce comb honey, and but a few hives are kept, then sections folded and with starters in place had better be purchased, but with ten or more hives and time during the winter season to prepare sections for the harvest, a section folder and a foundation fastener, costing together about \$3, may be profitably added to the outfit. If only extracted honey is wanted a honey extractor with one or two uncapping knives should be purchased instead of the section folder and foundation fastener, the cost of the outfit being in this case some \$15 to \$18. Fifty or even seventy-five hives may be managed conveniently and economically with no greater investment in implements than that indicated above, and if both comb and extracted honey are wanted the cost of the outfit, it can readily be seen, need not exceed \$20.

HIVES.

In regard to the particular style or form of hive to be used to insure the best results, it should be stated that while an intelligent apiarist whose experience has been considerable may be successful with almost any hive, even with poor ones, there can be no doubt that a hive not only adapted to the nature of the bees but also to the climate of the bee keeper's particular locality, and at the same time permitting the rapid performance of all operations necessary in securing surplus

honey, will very materially affect the net profit of an apiary. This being the case, the original cost of a hive, whether a dollar or two more or less, is of small importance compared with the desirability of securing convenience and simplicity in its management and of promoting the welfare of the bees in winter and summer. Frame hives managed with intelligence and skill are essential to the greatest success. Inaccurately made frame hives, neglected, as is too frequently the case, so that the combs are built irregularly between or across the frames, are not one whit better than box hives. Even an accurately built frame hive, if no attention is given to the spacing of the frames when combs are being built, will soon present no advantages over a box hive of the same dimensions and having the same space for supering above the brood apartment.

The frame and hive most in use in this country is the invention of Rev. L. L. Langstroth, and this hive, with slight modifications, has been generally adopted in England and her colonies. It is also becoming known and appreciated on the continent of Europe. The patent on the frame—the essential feature—expired many years ago, so that anyone who may wish to do so is now free to employ the invention. It is still used by many in the same form in which it was brought out in 1852. Others have changed the dimensions of the frames and given them different

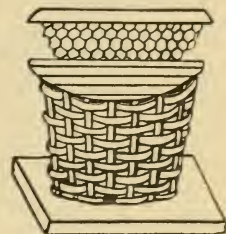

FIG. 22.—Ancient Greek movable comb hive. (After *La Maison rustique*, published in 1742.)

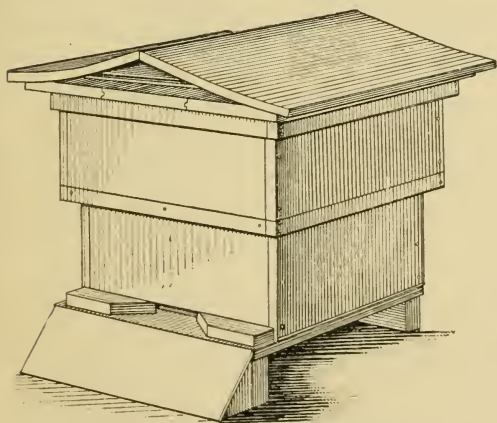

FIG. 23.—Dadant-Quinby form of Langstroth hive, with cap and gable roof. (Redrawn from Langstroth on the Honey Bee.)

many large honey raisers. Other sizes are also used somewhat.

The bars composing frames are usually made seven-eighths inch wide, although some prefer to have the top bar 1 inch or even $1\frac{1}{8}$ inches wide, and the bottom bar is made by some as narrow as five-eighths inch or even three-eighths inch square. The narrower bottom bar, at least down to a width of five-eighths inch, renders the removal of the frames

names, while retaining the special feature of the inventor's principle, namely, the loose-fitting frame suspended by the projecting ends of its top bar on a continuous rabbet. The outside dimensions of the Langstroth frame most in use are $17\frac{5}{8}$ inches long by $9\frac{1}{2}$ inches deep (fig. 24). Mr. M. Quinby, one of the most practical and successful beemasters of our century, preferred frames 12 inches deep by 18 inches long, and these are still used by

less difficult, and bees are brushed off a little more easily; but when combs cut from box hives are to be fitted into the frames it is not quite so easy to hold the pieces in the center of the frame by means of transferring sticks and get the bees to fasten them securely at the bottom as

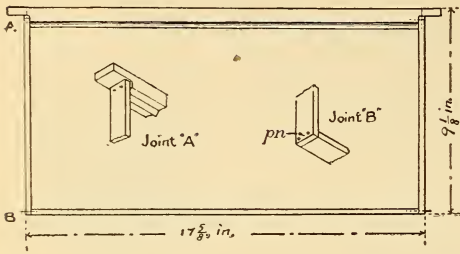

FIG. 24.—Langstroth frame; size, $17\frac{5}{8}$ in. by $9\frac{1}{8}$ in. outside; *pn*, projecting nail. (Original.)

it is with full seven-eighths-inch bottom bars. Top bars have been made by some hive manufacturers from one-fourth-inch to three-eighths-inch strips, strengthened somewhat by a very thin strip placed edgewise on the underside as a comb guide; but such bars are much too light and will sag when filled with honey or with brood and honey, and when section holders or other receptacles for surplus honey or sets of combs are placed above them more than a bee space exists between the upper and lower sets of frames or between the section holder and the frames below, and the bees will fill in with bits of comb between these, making it difficult to remove the top story or any of the combs from it; indeed, an attempt under such

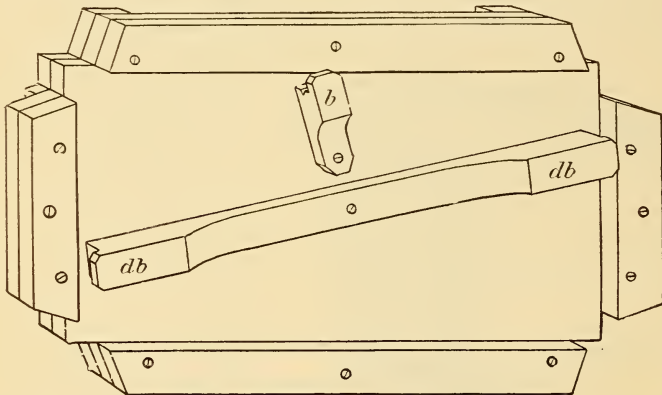

FIG. 25.—Form in which to nail frames: *b*, button; *db*, double button. (Original.)

circumstances to remove combs from the top story generally results in tearing the frames apart and breaking the combs, and if honey leaks out robbing may be induced at some times of the year, all because of an error in construction. To avoid this the top bar should never be less than five-eighths inch to three-fourths inch thick, while for long top bars seven-eighths-inch or 1-inch strips are preferable. The side and bottom bars may be made of one-fourth-inch strips. A corner is taken from the end of the top bar by a cross cut made at exactly right angles on the underside of the top bar, reaching to within one-fourth inch of the top of the bar, and another cut from the end so as to meet the first-

mentioned one. Each side bar can then be nailed by one nail driven from above through the top bar, and two driven through the side bar itself into the end of the top bar. The bottom bar can then be nailed on, or, better still, cut short enough to permit it to be inserted between the side bars, the nails holding it to be driven through the latter. Nailing frames loosely or without getting them exactly in true brings with it great disadvantages. If only slightly out of shape they may swing together at the bottom or touch the sides of the hive, and in either case will be glued fast by the bees; also in the first instance the combs, which are always built per-

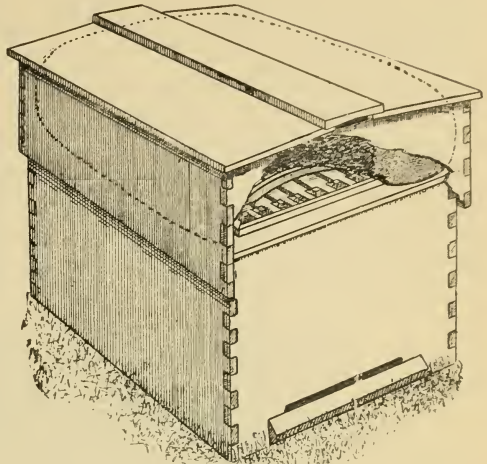

FIG. 26.—Lock-joint chaff hive. (From Gleanings in Bee Culture.)

pendicularly, will not be wholly within the frames. To avoid these troubles it is essential, first, that the parts for the frames be cut very accurately; second, that the frame be in exact shape at the time of nailing; and third, that the nails be driven in quite firmly; long, slender, flat-headed wire nails being necessary to secure proper stiffness of the frame. Nails $1\frac{1}{2}$ to $1\frac{3}{4}$ inches long made of No. 16 or No. 17 wire, or 4d. fine wire nails are the right size. Nailing in a form, such as is shown by fig. 25, is therefore advisable.

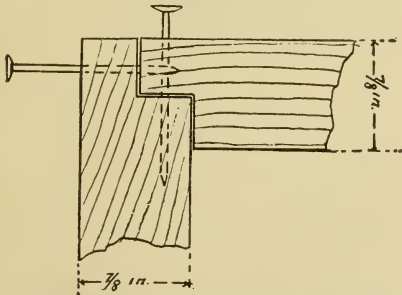

FIG. 27.—Manner of nailing hives. (Original.)

bees, and hence allow more rapid manipulation. (Fig. 24, *pn.*)

The hive to hold the frames should be the plainest kind of a box, the frames resting on rabbets made in the upper edges. Constructing it with lock joints, as shown in fig. 26, or by halving together the ends of the boards, as in fig. 27, and, in either case, nailing in both directions makes a strong hive body. The latter may be single-walled for mild climates or where cellar wintering is practiced; but for severe regions it is advisable to have permanent double walls with the inter-

spaces filled with chaff, ground cork, or similar material, or else outer cases should be provided giving space between the latter and the hive proper for dry packing. As the bees always try to glue the frames fast by means of propolis, it is better to make them rest on strips of tin, galvanized iron, or band iron. The rabbet should therefore be made eleven-sixteenths inch deep, and the strip of iron or other metal frame-rest nailed on so that its edge will project upward five-sixteenths inch from the bottom of the rabbet. Folded strips of tin as made by manufacturers of apiarian implements are preferable to single strips nailed on, since they facilitate the sliding of frames and do not cut the top bars where the latter rest upon them (fig. 28). The projecting ends of the top bars being one-fourth inch thick, the bars themselves come within one-eighth inch of the upper edge of the hive. It is essential that the distance between the ends of the frames and the hive should not exceed three-eighths inch, lest in time of plenty the bees should build comb there; nor can less than one-fourth inch space be allowed, for if the bees can not readily pass around the ends of frames of the Langstroth type they will glue the frames to the side walls of the hive,

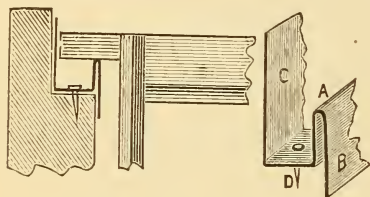

FIG. 28.—Section of improved tin frame-rest: A, folded edge on which frame rests; B and D, nails. (From Gleanings.)

making it very difficult, if not impossible, to remove them without breakage. If, as suggested, the frames are made one-fourth inch shorter at the bottom than at the top, that is, $17\frac{3}{8}$ inches at bottom and $17\frac{7}{8}$ inches at top, the hive should then be $18\frac{1}{2}$ inches inside from front to rear, the

frames running in this direction. If the frames are accurately made there will then be one fourth inch space at each end of the frame just below the top bar and three-eighths inch at each end of the bottom bar. Between the frames and the bottom board, on which the hive rests, one-half inch space answers, but five-eighths inch is preferable. The width of the hive will depend, of course, upon the number of frames decided upon, $1\frac{3}{8}$ inches being allowed for each frame, and three-eighths inch added for the extra space at the side. If a top story to contain frames for extracting is placed over the brood chamber, its depth is to be such as to leave the space between the two sets of combs not over five-sixteenths inch, and in this, as in the lower story, the space between the ends of the frames and the hive wall should be no more than three-eighths inch. A good way to keep rain from beating in between the stories and also to retain the warmth of the bees in outdoor wintering, yet admit of suitable provision for the upward escape of moisture, is to have the second story fit over the top of the lower one, and rest on ledges made by nailing strips around the latter one-half inch below the upper edge. As this makes the upper story nearly 2 inches larger from front to rear than the lower one; it will be necessary when arranging

this story for frames to make the front and rear double-walled. This is easily done by tacking on the inside of each end two half-inch strips, on which a half-inch board is then nailed. These inside end pieces should be only wide enough to reach within three-fourths inch of the top edge of the outer ends, and, like the lower story, should be finished at the top with a metal rabbet for the frames to rest on, or the inside piece may be made to come within three-eighths inch of the top and its upper edge beveled so the frames can not be greatly propolized, an arrangement which answers very well for this story.

As to the width of hives and consequent number of frames each story is to hold, there has been of late much diversity of opinion. The original Langstroth hive held ten frames in the lower story and

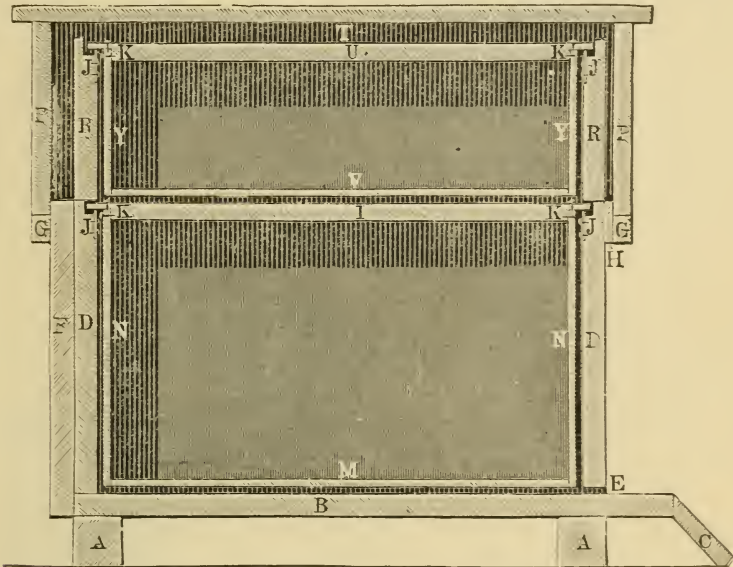

FIG. 29.—The Langstroth hive—Dadant-Quinby form—cross section showing construction. (From Langstroth.)

eleven frames in the second or top story. A demand for smaller-sized brood chambers and uniformity of the stories having been created, the larger hive-manufacturing establishments gave hives constructed to hold eight frames the most prominent place in their catalogues, and by many it was considered that those who adhered to the older, larger form did so merely through conservatism. But after some years' trial a reaction in favor of larger hives seems to have set in, especially among producers of extracted honey. Many of the latter are finding that with carefully bred queens even twelve-frame brood apartments give the best results. The author's experience of over twenty-five years with frame hives of various sizes and styles, both American and foreign, in widely differing climates, convinces him that to restrict a hive to a capacity of less than ten frames for the brood chamber is, in most

localities, undesirable, but it will frequently be found advantageous to contract temporarily the space occupied by the bees. For extracted honey alone, especially in any region having a short flow of honey, twelve-frame capacity is preferable. Thin, movable partitions, known

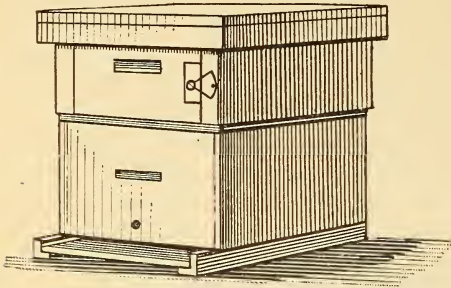

FIG. 30.—The Nonpareil hive. (From Bee-Keeping for Profit.)

as "division boards," enable one to contract the space at will, and the addition of supers or top stories gives storage room for surplus honey. Some prefer to have the hive in one story holding twice the usual number of frames and contractible with a division board. The entrance is then usually at one end, parallel with the combs, and the surplus honey is obtained from the rear part of the hive, either in sections held in wide frames or it is extracted with a machine from ordinary frames. This plan renders access to all of the frames somewhat easier than when two or more stories are used, but as the methods now most followed involve on the whole less manipulation of individual frames than was formerly deemed advantageous this superiority can not count for much—hardly enough in fact to balance the limitation as to the number of frames and the inconvenience of larger and more unwieldy hive bodies, covers, and bottom boards.

Small hives may yield excellent results in the hands of a skillful bee-master, but an equal degree of skill will, in general, give as good, if not better, returns from large hives, and the novice who may not know just when or how to perform all operations will find himself much safer with hives holding ten or twelve frames in each story, and far more likely to secure good returns from them than from smaller ones.

A good, tight roof or cover is indispensable, well painted, so that no drop of water can get in from above. A flat roof slanting from front to

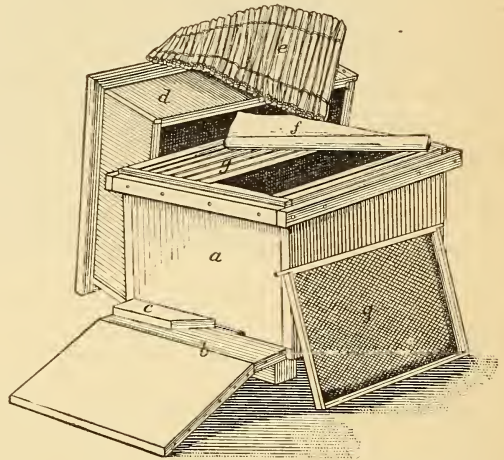

FIG. 31.—Dadant-Quinby form of Langstroth hive, open: *a*, front of brood apartment; *b*, alighting board; *c*, movable entrance block; *d*, cap; *e*, straw mat; *f*, carriage-cloth cover for frames; *g, g*, frames with combs. (From Langstroth.)

rear will answer, but a ventilated gable roof with the sides well slanted is far preferable. Above the sections or the upper set of frames a piece of carriage cloth, enameled side down, should be laid during the summer season to prevent too great escape of heat above and to keep the bees from getting into the roof or propolizing it. The cloth is more suitable than a board, since the latter when propolized can not be removed without considerably jarring the bees. If the carriage cloth be weighted with a board which has been clamped with a strip across each end to prevent warping, there will be less propolization of the sections above or building of bits of comb on the tops of the frames when these have been used. To dispense with this extra piece and also to render the gable cover flat on the underside, the board which rests on the carriage cloth may be nailed to the cover permanently. During very hot weather the quilt may be turned back and the cover propped up.

The bottom board to the hive may be nailed permanently or the hive may be merely placed on it. In either case the sides and back of the hive should be wide enough to come down over the edges of the bottom board and thus shed all water that runs down the outside of the hive. A sloping board in front will facilitate the entrance of heavily laden bees and many that fall to the ground will crawl in if the hive is within 8 or 10 inches of the ground. Many persons place the bottom boards directly on the ground, and the majority have them but 3 or 4 inches above the surface. By arranging them farther from the ground, at least 6 or 8 inches, dampness is avoided and the ease in manipulation is greatly increased. English manufacturers make the Langstroth hive with permanent legs some 6 or 8 inches long. This is no doubt necessary in the damp climate of that country, and even here the free circulation of the air beneath the hive and the entrance of direct rays of sunlight at times are so beneficial that there might well be a return to this valuable feature, which was part of the original Langstroth hive.

Great accuracy of parts must be insisted upon in hives and frames, both because covers and top stories should be made to fit interchangeably, and because the bees carry out their own work with great precision, so that ease in manipulation of combs can only be secured by nice adjustment. Hives cut by machinery are therefore greatly to be preferred, and though most of those kept in stock by apiarian manufacturers do not include in their construction all of the features mentioned above, they still answer in most particulars the requirements of bee life, and, if proper protection for the winter be afforded, are very serviceable.

IMPLEMENTS.

BEE SMOKERS.

No well-appointed apiary in these days is without one or more bee smokers. The professional bee keeper who has once used a bellows smoker would as soon think of dispensing with this implement as a

skillful cook would be disposed to go back from the modern cooking range to the old-fashioned fireplace.

For hundreds of years smoke has been used to quell and even stupefy bees, and various forms of bee smokers have long been used; but the modern bellows form, so far superior to the old clumsy implements which oftentimes required both hands of the operator, or to be held between the teeth, is purely an American invention. Mr. M. Quinby, one of the pioneers in improved methods in apiculture in America, was the inventor of the bellows smoker having the fire box at the side of the bellows so arranged as to enable the operator to work it with one hand, and when not in use to stand it upright and secure a draft which would keep the fire going.

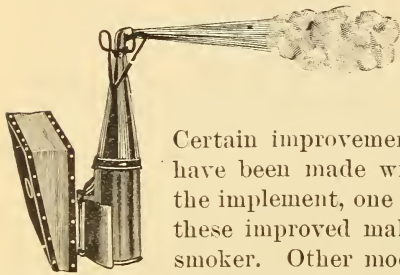

FIG. 32.—The Bingham bee smoker.

Certain improvements on the original Quinby smoker have been made without changing the general form of the implement, one of the most effective and durable of these improved makes being the Bingham direct-draft smoker. Other modifications are the Crane, with a cut-off valve, the Clark, Hill, and Corneil smokers. The

medium and larger sized smokers, even for use in small apiaries, are preferable. They light easier, take in all kinds of fuel, and hold fire better, while they are always much more effective since they furnish a large volume of smoke at a given instant, thus nipping in the bud any incipient rebellion. The bee smoker and its use are well shown by figs. 12, 32, and 53.

VEILS.

Veils for the protection of the face will be needed at times—for visitors if not for the manipulator. The beginner, however, should use one under all circumstances until he has acquired some skill in opening hives and manipulating frames and has become acquainted with the temper and notes of bees, so that he will have confidence when they are buzzing about him and will know when it is really safe to dispense with the face protector. Veils are made of various materials. In those which offer the least obstruction to the sight, black silk tulle or brussels net is used, the meshes of which are hexagonal. Linen brussels net is more durable than silk, as is also cotton, though the latter turns gray in time and obstructs the vision. By making the front only of silk and the sides of some ordinary white cotton netting the cost of the veil is less, but it is not so comfortable to wear in hot weather, being less open. A rubber cord is drawn into the upper edge, which brings the latter snugly in about the hat band. By having the veil long and full and drawing it over a straw hat with a wide, stiff brim, tying the lower edge about the shoulders or buttoning it inside a jacket or coat, the face is securely protected. (Fig. 12.)

HONEY EXTRACTORS AND HONEY KNIVES.

The honey extractor (fig. 33) consists of a large can, within which a light metal basket revolves. The full combs of honey, from which the cappings of the cells have been removed by a sharp knife, are placed inside the basket and after several rapid revolutions by means of a simple gearing are found to have been emptied of their contents. The combs, only very slightly damaged, can then be returned to the hives to be refilled by the bees. If extra sets of combs are on hand to supply as fast as the bees need the room in which to store honey, great yields can often be obtained. A good extractor should be made of metal, and the basket in which the combs are revolved should be light, strong, and doubly braced on the outside so that the wire-cloth surface, against which the combs press, will not yield. The wire cloth used, as well as all interior parts of the extractor, should be tinned,

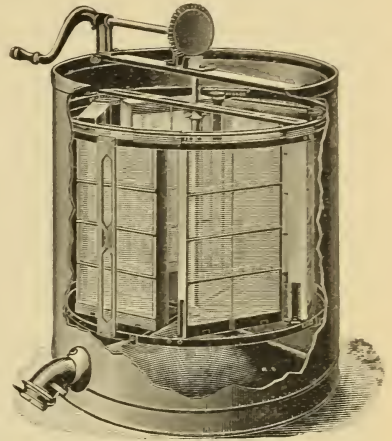

FIG. 33.—Williams' automatic reversible honey extractor.

as acids of honey act on galvanized iron, zinc, iron, etc. Wire cloth made of coarse wire and with meshes one-half inch square is often used, but it injures the surface of new combs and those very heavy with honey more than that made of about No. 20 wire and with one-fourth-inch meshes.



FIG. 34.—Quinby uncapping knife.

knife, known as an uncapping knife, is needed (figs. 34 and 35). The blade, which should be of the finest steel to hold a keen edge, is fixed at such an angle with the handle as to keep the hand that grasps the latter from rubbing over the surface of the comb or the edges of the frames. The form of knife with curved point is best adapted to reach any depression in the comb, which, if uncapped and emptied of its honey, will likely next time be built out even with the general surface. Dipping the knife in hot water facilitates rapid work, and of course the heavier-bladed knives hold the heat better than thin-bladed ones, and are for this reason preferred by some; also because they more surely lift the capping clear from the surface of the comb.



FIG. 35.—Bingham & Hetherington uncapping knife.

21471—No. 1—4

WAX EXTRACTORS.

A solar wax extractor is needed in every apiary; several are kept running in many large apiaries. Extractors which render wax by steam are also used. To the latter class belongs the improved Swiss wax extractor (fig. 36). This implement, invented in Switzerland and improved in America, consists of a tin or copper vessel with a circle of perforations in the bottom near the sides to let in steam from a boiler below, and within this upper vessel another receptacle—the comb receiver—made of perforated zinc. Its use, as well as that of the solar wax extractor, is described under the head of “Wax production.”

Within a few years wax extractors employing the heat of the sun and known as solar wax extractors have come into general use (fig. 61). The essential features in all the forms that have been devised are a metal tank with a glass cover and usually a wire-cloth strainer, below

which is placed the receptacle for the wax, the whole so arranged as to enable one to tilt it at such an angle as will catch the direct rays of the sun. The effectiveness of the solar wax extractor is increased by having the glass doubled, and adding also a reflector, such as a mirror or a sheet of bright metal.

An important advantage of the solar wax extractor is the ease with which small quantities of comb can be rendered. By having this machine much is therefore saved that might be ruined by wax moth larvæ if allowed to accumulate, besides serving at the same time to increase these pests about the apiary.

The wax obtained by solar heat is also of superior quality, being clean, never water-soaked nor scorched, and also light in color, owing to the bleaching action of the sunlight.

The cost of a medium-sized solar wax extractor does not exceed that of the larger Swiss steam extractors, yet of the two the former is likely to prove by far the more valuable, even though it can be used only during the warmer months.

QUEEN-INTRODUCING CAGES.

In every apiary there should be several of these on hand. The best are such as permit the caging of the queen directly on the comb over cells of honey. A little practice will enable anyone to make very serviceable and cheap cages for introducing queens. From a piece of wire cloth having ten to twelve meshes to the inch cut a strip 2 inches wide; cut this in pieces $4\frac{1}{4}$ inches long, roll each piece around a stick to give it a cylindrical form, lap the edges, and sew with a piece of wire. Then in one end of this cylinder make slits three-quarters inch

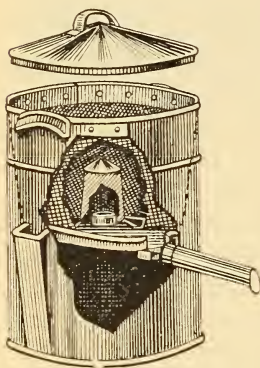

FIG. 36.—Excelsior wax extractor.

apart and three-quarters inch deep, and bend over the tongues thus formed so as to close this end of the cage. With the flat end of a pencil press warm wax or comb into the bottom inside to give it firmness. Then unravel five or six strands of the wire cloth at the other end. The wire points left after unraveling these strands may be pressed into the comb so as to confine a queen and four or five of her attendant workers. (Fig. 66.)

Most of the queen-mailing cages are arranged to admit of their use in introducing the queens also, so that when received it is only necessary to withdraw a cork and place the cage on top of the brood frames, thus admitting the bees to the candy. They will eat their way in and release the queen in twenty-four to forty-eight hours. This plan is very good for such as lack experience in handling queens, and hence might injure them by grasping the abdomen, by pinching the thorax too hard, or by catching the legs on the wire cloth of the introducing cage.

BEE FEEDERS.

During warm weather liquid food may be placed in any open receptacles which can be set in the upper stories of the hives. Tin fruit or vegetable cans that have been used may be made to serve the purpose, a wooden float for each or some bits of comb being put in to keep the bees from drowning; but during cool weather feeders arranged to admit the bees but not permit the escape of heat had better

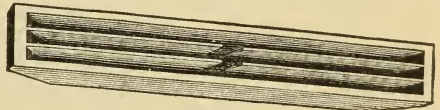

FIG. 37.—Simplicity feeder. (From A B C of Bee Culture.)

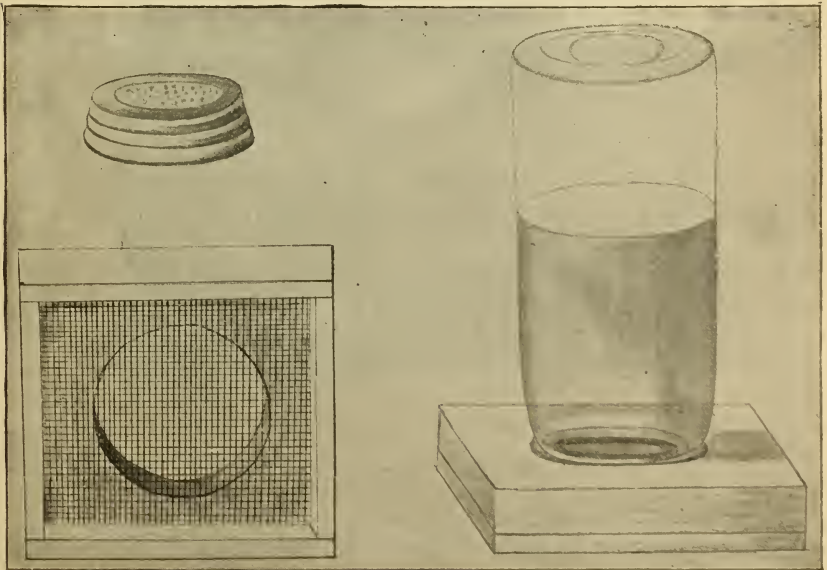

FIG. 38.—Fruit-jar bee feeder. Bottom of feeding stage and perforated cap shown separately. (Orig.)

be employed. Glass fruit jars with metal caps are generally at hand, and make excellent feeders by merely punching a few holes in each cap. After the jar is filled with liquid food and the cap screwed on tightly it is inverted over a feed hole in the quilt or honey board. The cap, or top story, with cover, protects the whole, and it is very easy to see when more food is wanted by merely raising the cover slightly. If arranged on a feeding stage covered on the underside with wire cloth, as shown in fig. 38, feeding may be accomplished without being troubled by the workers.

Feeders of various forms constructed of wood or tin, or of these materials combined, most of them serving the purpose excellently, are offered in catalogues of apiarian manufacturers.

SECTION FOLDERS.

Sections can be folded or put together readily over an accurately made block just large enough to fill the space inclosed by a section, and several machines to facilitate the work in case it is to be done on a large scale have been devised.

BEE ESCAPES.

The bee escape (fig. 39) is an important labor-saving invention for the honey producer. A number of them may be regarded as necessary in every apiary. They are inserted in holes bored in a honey board and used in freeing supers from bees, as described under "Honey production."

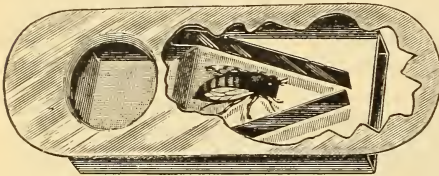

FIG. 39.—The Porter spring bee escape.

FOUNDATION FASTENERS.

For sections.—Several styles of implements for fastening thin foundation in sections have been devised. All of them do the work well. A simple one, which is also low priced, is Parker's; Clark's and the Daisy are also highly recommended, and A. C. Miller's is very complete, working automatically. The latter, and the Daisy shown in fig. 40, each require the use of a lamp.

For frames.—If the top bars of the frames have a slot or saw kerf one-eighth to three-sixteenths inch deep on the underside, made by passing them lengthwise over a circular saw, sheets of foundation can be very readily fastened by slipping the edge into this groove and running melted wax along the angle formed on each side by the foundation and the top bar. Or a wedge-shaped strip may be crowded in at the side and secured with small wire nails. If the top bar is flat on the underside it will be necessary to press the foundation firmly against it; that is, to incorporate the edge of the wax sheet into the wood of the top bar by rubbing it with a smooth bit of hard wood or bone, such as a knife handle,

moistening this implement to prevent the wax from sticking, and then fix it firmly by pouring melted wax down the other side. In the case of top bars having triangular comb guides or a projecting tongue on the underside the foundation can be securely fastened by merely cutting five or six slits three-eighths to one-half inch deep in one edge of the foundation and bending the tongues thus formed in alternate directions so as to place the V-edge of the top bar between them, when they can be firmly attached to the top bar by rubbing with a knife handle as before. Soapsuds or starch water may be used to advantage in moistening the knife handle. The foundation roller (fig. 41), a small disk of hard wood which revolves in a slot at the end of a handle and costs but a few cents, does effective work in fastening foundation in brood frames; in fact, it is rather better than the knife handle for the work just mentioned, except that it will not reach into the corners of the frames, and to secure the foundation there the knife handle must still be used. The roller will need to be moistened the same as the knife handle.

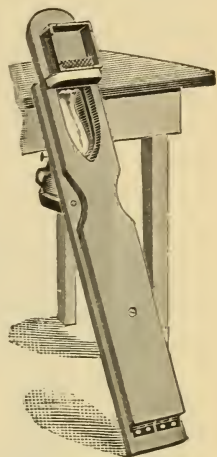

FIG. 40.—The Daisy foundation fastener. (From Gleanings.)

It is particularly important that the sheets of foundation be well fastened, for if one edge breaks loose with the weight of the bees it will crumple down in such a way as not only to run that comb, or rather to prevent the building of a good comb in the frame in question, but also



FIG. 41.—Fastening starter of comb foundation in frame. (Original.)

very likely in the adjoining frames if they have not been previously built out; and in this case damage will probably result to them. To prevent bulging of the comb it is also essential that the sheets of foundation, if not wired, be narrower than the inside depth of the frame and shorter than its inside length. A full inch of space should be

allowed between the bottom bar and the sheet of foundation, and a half inch at each end for two-thirds of the way up.

With these precautions swarms may even be hived on full sheets of foundation without wiring the frames; but the practice will probably continue of using starters, chiefly in the case of swarms, and, when full sheets are employed, of alternating them with combs already built out. Some prefer to wire the frames even though it is considerable trouble, for the combs require less attention while in process of construction and are firmer for shipping, for use in the extractor, or for any other manipulation. Three or four horizontal wires will suffice. No. 30 annealed tinned wire is the preferable size and quality. The end bars of the frame are pierced by four holes, the first 1 inch below the top bar. A small tack secures the end of the wire, which is then passed back and forth and drawn up so as to leave no slack. The four horizontal wires, 2 inches apart, will be sufficient to render combs quite secure. After fastening the foundation to the top bar in

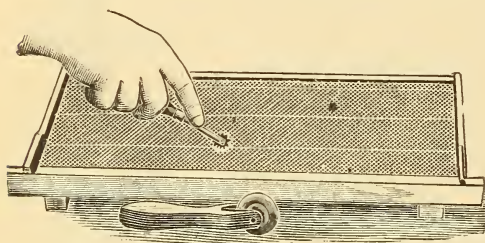

FIG. 42.—Spur wire-embedder. (From Gleanings.)

the usual way the wires are embedded in the wax by a spur embedder, which is a small wheel with grooved teeth (fig. 42). Where large numbers of frames are to be wired a current of electricity from a small battery will do the work more neatly and quickly than the spur embedder.

The disadvantages of wiring frames are, first, its expense, caused chiefly by the time employed in doing it; and second, the fact that wherever the wire does not get embedded into the midrib of the foundation, as is sure to happen in many cases, the rearing of brood is interfered with, and also, under the methods employed by the majority in wintering, moisture is very likely to cause the combs to cleave from the wires, whereupon the bees are disposed to gnaw the combs away from the wires in spots and not rebuild them.

These disadvantages, except that of expense, are overcome by incorporating fine wire in the sheets of foundation when they are rolled. The sheets are trimmed with wooden shears, which leave the ends of the wires projecting. These are then glued to the bars of the frame. The added expense is again the main objection, except to those who wish to ship colonies or nuclei, or transport them from place to place for pasturage.

COMB-FOUNDATION MACHINES.

The first attempts to give bees outlines of cells as a basis for comb building were made in Germany. The top bars of the frames were coated on the underside with beeswax, and a strip of wood having

the outlines of bees' cells cut on it was then pressed against this wax so as to form a guide which should lead the bees to build their combs within the frames. This was only a comb guide, but was succeeded by small strips of wax having the outlines of bees' cells pressed on them by hand, a block of wood being engraved for this purpose. The general use of comb foundation, especially of the full sheets, was only made possible through the improved means of manufacturing it developed in the United States. The slow process of hand stamping was succeeded by its rapid production on machines, the essential feature of which is two engraved cylinders between which the warm sheet of wax is made to pass (fig. 43). Such machines are now made in numerous patterns costing from \$15 up. Foundation is made with flat-bottomed cells and also with the same form as that given by the bees to combs constructed wholly by themselves. Both sorts are readily accepted by the bees and built out. Both these kinds are also made in various qualities and weights. Only a good quality of perfectly pure beeswax should be accepted. Brood foundation is made in light, medium, and heavy weights. For use in section boxes thin surplus and extra thin surplus are made of light-colored wax. When full sheets are used in sections it is better to have it extra thin lest there should be a noticeable toughness of the midrib, technically known as "fishbone." For unwired frames the medium or heavy brood-comb foundation should be employed.

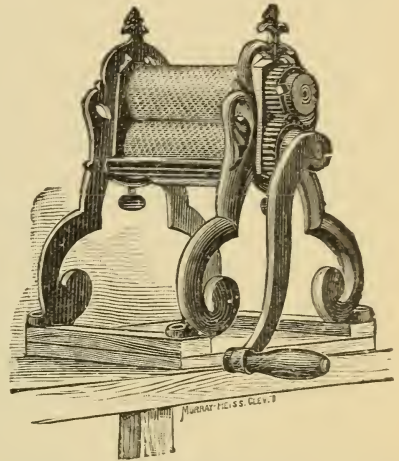

FIG. 43.—Comb-foundation machine. (From Langstroth.)

Until used it is best to keep comb foundation between sheets of paper and well wrapped, since if long exposed to the air the surface of the wax hardens somewhat, but if well packed it may be used years after it was made with almost the same advantage as when first rolled out.

It requires considerable skill to make foundation successfully, and those who use but a small amount will do better to purchase their supply. The high quality of nearly all of the foundation thus far supplied in this country has also justified this plan. Should the practice of adulterating wax become as common among comb-foundation manufacturers in this country as on the continent of Europe no doubt many more would procure machines and make their own foundation.

CHAPTER VI.

BEE PASTURAGE.

Bees obtain their food from such a variety of sources that there are few localities in our country where a small apiary could not be made to yield a surplus above its own needs. Even in the center of our larger cities bees placed on the roofs of stores and dwellings have often furnished quite a surplus gathered from the gardens of the city and its environs. Again, in regions where the soil is too light, rocky, or wet to admit of profitable cultivation, it is often the case that honey-producing plants abound; indeed, waste land is frequently far more profitable for the honey-producer than fields that have been brought under cultivation, especially when the latter are mainly devoted to grain or potato raising, for insignificant weeds in field or swamp often yield honey abundantly, and among the best yielders are certain forest trees, whose blossoms, by reason of their distance from the ground and in some instances their small size, escape notice. Showy flowers made double by the gardener's skill, such as roses, dahlias, chrysanthemums, etc., have rarely any attraction for our honey bees. Moreover, the small number of these ornamental plants usually found in any one locality renders the honey yield, even in case they are abundant secreters of nectar, so slight that they are of little value. The novice who is seeking to determine the honey resources of his locality should therefore not be led into error by these. He should compare the flora of his locality with reliable lists of honey-producing plants, and, if possible, consult some practical beemaster familiar with his surroundings. And all information on this score should be fully accepted only after careful verification, as it is very easy for anyone to be deceived regarding the sources of given honey yields—plants which produce abundantly one season not always yielding the next, or those that produce honey freely in one portion of the country not yielding anything in another. Soil and climate, the variations of successive seasons, and all other conditions affecting plant growth—conditions which even the most skillful scientific agriculturists admit are exceedingly difficult to understand, and in many respects, as yet unexplainable—influence the amount and quality of nectar secreted by a given plant

The danger of overstocking is largely imaginary, yet in establishing a large apiary it is of course essential to look to the natural resources of the location, and especially to decide only upon a place where two or more of the leading honey-producing plants are present in great numbers. In the North, willows, alder, maples, dandelion, fruit blossoms, tulip tree (frequently called whitewood), locust,

clovers (white, alsike, crimson, and mammoth red), with alfalfa and melilot, chestnut, linden or basswood, Indian corn, buckwheat, fireweed, willow-herb, knotweeds, mints, cleome, golden-rods, Spanish needle, and asters may be cited as the chief sources of pollen and honey; and of these the tulip tree, locust, white clover, alfalfa, melilot, linden, and buckwheat furnish most of the surplus honey. The fruit blossoms, with the exception of raspberry, come so early that a small proportion only of the colonies are sufficiently strong to store surplus,



FIG. 44.—Willow herb (*Epilobium angustifolium*). A, young flower: *s*, stigma turned back; *a*, anthers; *l*, lobe or pod. B, older flower: *s*, stigma turned forward; *a*, anthers; *l*, lobe. C, spike of flowers. D, section of pollen grain: *e*, extine; *i*, intine; *ti*, thick intine; *f*, fovilla. E, growing point of pollen grain: *e*, extine; *i*, intine; *f*, fovilla; *pt*, pollen tube. (From Cheshire.)

and of course this statement applies with still more force to plants which blossom before apple, pear, cherry, etc. Some of the clovers, mustard, rape, cultivated teasel, chestnut, barberry, sumac, coral berry, pleurisy root, fireweed, borage, mints, willow-herb, Spanish needles, cleome, etc., though yielding well, are only found abundantly over certain areas, and do not therefore supply any considerable portion of the honey that appears on the market, though when any of them are plentiful in a certain locality the bee keeper located there will find in nearly all cases that the surplus honey is greatly increased thereby.

In the middle section of our country, from Maryland, Virginia, and North Carolina westward, most of the sources named above are present, although the maples (particularly hard maple) furnish less, and fruit bloom, the clovers, linden, and buckwheat are not as great yielders as in the North. Sourwood or sorrel tree, mountain laurels, sour gum or tupelo, huckleberry, cowpea, magnolia, and persimmon make up in part for these, the sourwood being especially important, while in some localities certain species of asters yield very abundantly. The tulip tree (known commonly as poplar) is a greater yielder than in the North, while in the western portion of the middle section the Rocky Mountain bee plant or cleome and more extensive areas of alfalfa and melilot are very important sources.

In the more southern States fruit bloom is far from being as great a source of honey as in the North, though with the extension of orange groves in Florida and Louisiana an increased production of very fine honey may be looked for in those States. The titi, magnolia, palmetto, and black mangrove yield well in some parts, and sour gum (tupelo or pepperidge), cotton, and pennyroyal are sources not to be overlooked. In Texas horsemint and mesquite, the latter also extending farther West, furnish fine yields, while many mountain localities of southern California are clothed with white and black sages—wonderful honey producers. In certain localities there the orange and other fruit orchards, and also wild buckwheat, give the bees excellent pasturage for a portion of the year.

Certain small homopterous insects, such as plant-lice, bark-lice, mealy-wings, and some leaf-hoppers, which congregate on the leaves or bark of various plants and trees, notably pines, oaks, and beeches, and suck their juices, secrete a sweet liquid, which is often taken up by bees as it falls on the surrounding vegetation. This secretion, commonly known as honeydew, or plant-louse honey, is usually of an inferior quality, though that from pine-tree aphides is sometimes fairly good. Most of it granulates very soon after having been gathered, sometimes even before the cells have been sealed.

Under peculiar conditions of the atmosphere sweet exudations, also known as honeydew, drop from the leaves of certain plants and are eagerly taken up by the bees. This substance is sometimes very abundant and of excellent quality. It should not, however, be confounded with the secretions of extra-floral glands such as are possessed by the cowpea, horse bean, partridge pea, and vetches. These seem to be natural productions for the purpose of attracting insects to the plants, while the former is apparently an accidental exudation through the plant pores, brought about very likely by some sudden change of temperature. Both are, however, merely the saccharine juices of the plant, and when refined by the bees may become excellent honey.

CULTIVATION OF HONEY PLANTS.

In all localities there will probably be found intervals during the working season when bees will find very little or even nothing to gather, unless supplied by cultivation. When possible it is always best to fill in such intervals with some honey-producing plant which at the same time furnishes some other product—fruit, grain, forage, green manure, or timber. The attempt to cultivate any plant for its honey alone has not thus far been found profitable, in practice, however promising it may seem theoretically. Catnip (*Nepeta cataria*), motherwort (*Leonurus cardiaca*), globe thistle (*Echinops sphaerocephalus*), figwort (*Scrophularia nodosa*), bee balm (*Melissa officinalis*), borage (*Borago officinalis*), Rocky Mountain cleome (*Cleome serrulata*), melilot or sweet clover (*Melilotus alba*), and linden (*Tilia americana*) have all been recommended repeatedly and tried here and there somewhat



FIG. 45.—Wagner's flat pea (*Lathyrus sylvestris wagneri*).

extensively. But thus far the hope of securing a sufficient increase in the crop of honey to pay for the cultivation of these plants has in all cases had to be abandoned. With the appreciation in value of agricultural lands the prospects for the profitable cultivation of any crop for honey alone are still further removed. Yet the writer is fully convinced that in the future, especially in the older portions of our country, eminent success in bee raising will require much more attention to the furnishing of artificial pasturage for the bees, a close study, in fact, of the bee flora of one's locality, and a systematic effort to supply the deficiencies by sowing self-propagating honey plants, and such as may be cultivated with profit for other reasons besides their honey yield.

Among those plants which have just been mentioned as having been cultivated at various times for their honey alone, the linden for shade

and ornament as well as for timber, catnip for sale as an herb or to secure its seed, and melilot for forage or green manuring are the only ones which, under present conditions, might in some cases be profitably cultivated. There may be introduced with advantage, however, all



FIG. 46.—Dwarf Essex or winter rape (*Brassica napus*).

such honey-producing plants as, with one sowing or planting, will readily propagate themselves and without cultivation extend their area along roadsides and over waste lands, always excepting of course such as may become troublesome weeds. For this purpose most of the plants referred to above are available, and many others which like these are adapted to one portion or another of our country might be added, as, for example, pleurisy root or butterfly weed (*Asclepias tuberosa*), Indian currant or coral berry (*Symphoricarpos symphoricarpos*), viper's bugloss (*Echium vulgare*), lady's thumb (*Polygonum persicaria*), horsemint (*Monarda citriodora*), willow-herb (*Epilobium angustifolium*), etc., but of course it can not be expected that they will thrive and thoroughly establish themselves without further attention, except in such localities as present very favorable conditions for their growth. Furthermore, there is always the risk that a plant which yields honey abundantly in one part of the country may not do so in another region, even though it grows well, so that it is necessary in most cases, especially with wild plants, to test them anew before extensive introduction, no matter how well established their reputation as honey producers may be elsewhere.

Among plants of economic value in other directions fruit trees and shrubs are to be counted as of much importance to bees. The apple and the cherry yield well, the others less, though the gooseberry, were it more plentiful, would be of considerable value. Strawberry blossoms are, in general, visited sparingly and yield only a small amount, but the raspberry, coming later, when the colonies are stronger, is a most important source, greatly liked by the bees, and furnishing as fine a quality of honey as is known. Ten acres



FIG. 47.—Summer or bird rape (*Brassica napus*).

in raspberries will furnish pasturage for three weeks to 75 or 100 colonies of bees. Mustard for seed, and rape for pasture and seed, may be made to furnish much to the bees in early spring. Buckwheat honey is dark and strong, but is relished by some, and when well ripened is good winter food for bees, so that whenever this plant can be made to blossom at a time when the bees find nothing better and a crop of grain can



FIG. 48.—Sacaline or giant knotweed (*Polygonum sachalinense*).

also be harvested from it, a plentiful supply should by all means be sown; the clovers, white, alsike, crimson, and mammoth or medium red may be sown for pasturage, hay, forage, for purposes of green manuring, or for seed, and honey of fine quality obtained if a sufficient number of blossoms are allowed to appear. Alfalfa (*Medicago sativa*), a most important honey producer as well as perennial forage crop, can be grown over a much greater area of the United States than has heretofore been generally supposed. Sainfoin (*Onobrychis sativa*) and serradella (*Ornithopus sativus*), both most excellent honey plants, have not received the attention they merit either North or South. Japan clover (*Lespedeza striata*) is grown profitably in the South, and more even might be expected from the introduction of sulla clover (*Hedysarum coronarium*) there, the latter a great honey producer. Chicory, even on poor soil, is a good honey and pollen plant. Northern bee keepers should try the dwarf (quick-growing) varieties of cowpeas (*Vigna sinensis*) extensively grown in the South for forage and green manuring. Vetches are of recognized value for the same purposes, especially the Russian hairy vetch (*Vicia villosa*). Sacaline (*Polygonum sachalinense*) and flat peas (*Lathyrus sylvestris*) are visited by bees, and in certain situations may be found of value otherwise. Peppermint (*Mentha piperita*) yields well in July and August. Parsnips (*Pastinaca sativa*) when grown for seed are assiduously visited by bees for honey during June, July, and August. Gorse or furze (*Ulex europaeus*) for forage may prove valuable in some localities here, as it is highly esteemed in some parts of Europe. Its odorous yellow blossoms, much frequented by bees, appear in May. Filbert bushes (*Corylus avellana*) will grow in many portions of our country, yielding, besides nuts, an abundance of early pollen, even in February or March. The carob tree (*Ceratonia siliqua*) succeeds in the Southwest, yielding a



FIG. 49.—Russian or hairy vetch (*Vicia villosa*).

crop of economic value, besides a harvest in late summer for bees. It is also a fine ornamental tree. There are no finer shade or ornamental trees for the lawn or roadside than lindens (basswoods) and horse-chestnuts. To these chestnut, locust, sourwood, and tulip trees may be added. The timber of all is useful; and since they are great honey yielders their propagation near the apiary is very desirable.

Bees range ordinarily within 2 or 3 miles in all directions from their homes, but sometimes go farther. Pasturage to be especially valuable, however, should be within 2 miles, and less than a mile distant to the main source is quite preferable. The advantage is probably not so much in the saving of time in going back and forth, for bees fly with great rapidity, but because when sudden storms arise, especially those accompanied by high winds, the heavily laden bees are more likely to reach home safely and the hive will not be decimated of its gathering force.

BEES AS CROSS-FERTILIZERS.

Allusion has already been made in this bulletin to the importance of bees in the complete cross fertilization of fruit blossoms and to the fact that certain varieties of pears have been found to be completely self-sterile, requiring, therefore, pollen from other varieties before they can develop perfect seeds and fruits. It is interesting to study the ways in which cross fertilization of plants is secured through the visits of insects. The part that bees perform in the development and perpetuation of numerous ornamental and economic plants is thereby clearly shown. Space will only permit the introduction here of one or two examples. The willow-herb, which is an abundant secreter of nectar and thus attracts bees freely, illustrates one feature in pollination by bees. A young blossom of this plant (fig. 44, A) shows the stamens maturing and shedding their pollen, while the pistil remains curved downward and with closed stigmas. In the older flower (fig. 44, B), the stamens having shed their pollen and begun to wither, the pistil has straightened up and exposed its stigmatic surfaces for the reception of the pollen which a bee chancing to come from a younger blossom is likely to bring. Self-pollination is thus positively prevented and cross fertilization is insured.

In the mountain laurel the anthers are held securely by little pockets in the corolla, so that as the flower opens the stamens are found bent over (fig. 50, B) ready to be liberated (fig. 50, C) by the visit of a bee. When the stamen flies up the pollen is discharged from the anther and dusted on the underside of the bee. The latter as it alights on the next flower naturally touches the stigma first and rubs off some of the pollen it has brought from the last flower visited. It then proceeds to secure the nectar of the flower on which it has just alighted, and in doing this liberates the stamens of this flower and gets dusted again with pollen, which it carries to the next flower.

The cross section of an imperfectly developed apple shown herewith (fig. 51, B) illustrates the importance of complete fertilization of fruit

blossoms. The seed vessel at *u* shows only an abortive seed, and the side of the fruit nearest this point is also correspondingly undeveloped. This is owing to imperfect or complete lack of fertilization of this carpel, five distinct fertilizations being necessary to produce a perfect

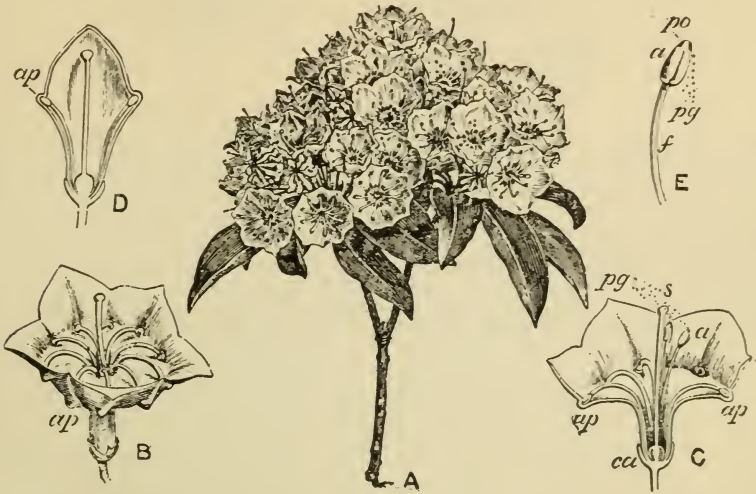

FIG. 50.—Mountain laurel (*Kalmia latifolia*). A, flowering branch. B, expanded flower: *ap*, anther pocket. C, section of expanded flower: *ap*, *ap*, anther pockets; *s*, stigma; *a*, anther (free); *pg*, pollen grains in shower; *ca*, calyx. D, section of flower bud: *ap*, anther pocket. E, stamen more enlarged: *a*, anther; *po*, pores; *pg*, pollen grains; *f*, filament. (From Cheshire.)

fruit. Bees being, during the period of fruit blossoms, the most abundant insects that might effect the necessary distribution of the pollen of these flowers, the importance is at once seen of having an apiary in or near the orchard. Continued rainy or cold weather may keep the bees confined to their hives much of the time during fruit bloom, hence

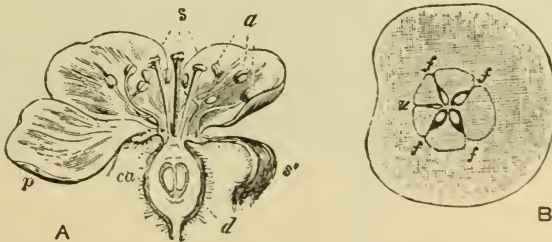

FIG. 51.—Apple (*Pyrus malus*), showing structure of flower and result of imperfect fertilization. A, blossom: *s*, stigmas; *a*, anthers; *p*, petal; *s'*, sepal; *ca*, calyx; *d*, dissepiment. B, cross section of imperfectly developed fruit: *f*, *f*, fertilized carpels; *u*, unfertilized carpel. (From Cheshire.)

it is advisable to have them near at hand and in numbers proportionate to the size of the orchards, so that even a few hours of sunshine will assure their making a thorough distribution of the pollen. In the absence of accurate experiments regarding the number of colonies of bees required to insure proper fertilization in the orchard, and also in

view of the fact that surrounding conditions vary greatly, it is difficult to say exactly how many colonies are positively necessary for a given number of trees. However, four or five well-populated hives for every hundred large apple trees will doubtless suffice, even though no other hive bees are within a mile of the orchard. The bees of a neighbor's apiary are often quite sufficient for the orchardist's purpose, the benefit resulting from their labors being, therefore, mutual, though the orchardist doubtless derives in this case greater advantage from them than does their owner himself. Escaped swarms lodged in forest trees in



FIG. 52.—Heath-like wild aster (*Aster ericoides*). (Original.)

the vicinity of the orchard are sometimes sufficiently numerous to perform the work well. The great value of bees as cross fertilizers makes their destruction a serious injury to the interests of the fruit grower. Therefore spraying with arsenicals during fruit bloom should never be practiced. The injurious insects can be reached quite as well before and after the blooming period.

HONEY AND POLLEN PRODUCING PLANTS.

In the following lists the intention has been merely to indicate the main sources from which our hive bees secure honey and pollen. Anything like a complete enumeration of those plants of the United States



max del

ALFALFA (*Medicago sativa*).



ESPARCET OR SAINFOIN (*Onobrychis sativa*).

1, 2, 3, 4, parts of flower; 5, pod; 6, 7, seed.



Marx del

SWEET CLOVER OR MELILOT (*Melilotus alba*).

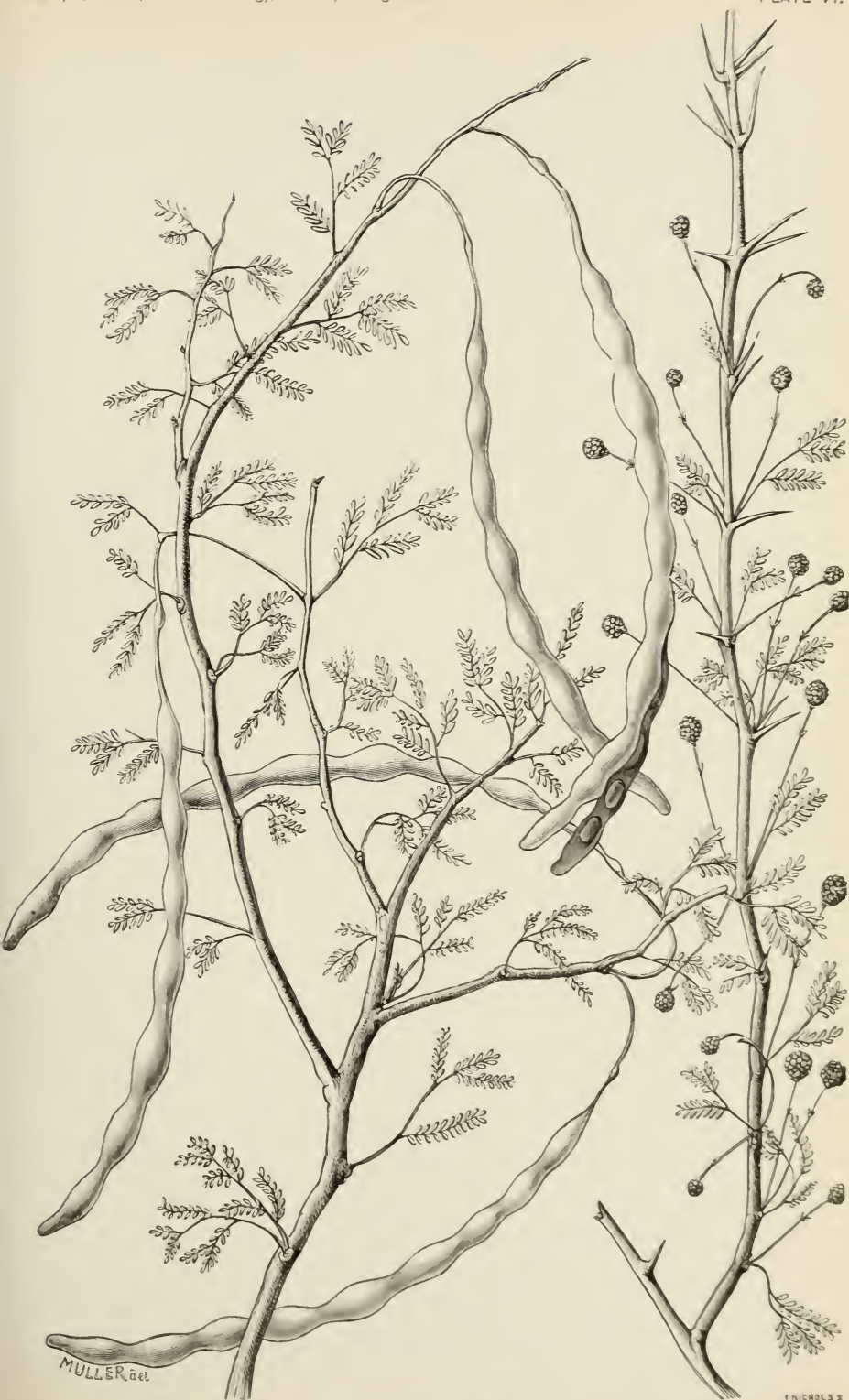

MULLER ael

ACACIA (*Leacia constricta*).

FINCHOLS 2



MESQUITE (*Prosopis juliflora*).



BLUE WEED OR VIPER'S BUGLOSS (*Echium vulgare*)



Cowing det.

CRIMSON CLOVER (*Trifolium incarnatum*).

V. REED, DRAWER



Coving del.

ALSIKE CLOVER (*Trifolium hybridum*).

visited by hive bees would occupy far too much space for a brief treatise like this. Many plants are therefore omitted which secrete nectar freely but which are abundant only locally; others are left out because they secrete only at rare intervals, or under peculiar conditions, or are visited by bees only when some better honey source fails; others again because, though secreting well and readily yielding their honey or pollen stores to the bees, they are not often present in sufficient numbers in any one locality to enable the bees to add materially to their surplus stores. Such plants are, however, often of great value because they cause the bees to rear brood during intervals between the times of storing surplus honey and thus keep the colonies populous for successive harvests.

Besides the main honey plants it would be easy to name for any locality quite a number of secondary importance which are frequented by honey bees, yet even though the localities were but a few miles apart scarcely any two lists would agree either as to the plants to be included or as to their relative importance. The following honey and pollen producing plants are therefore of wide distribution or of special importance in certain localities.

For convenience separate lists are given for the three sections of the United States made by the parallels of 35° and 40° N. The flora of the western portion of each section differs of course greatly from that of the eastern part of the same section. Only the most important honey yielders among those of local interest in the extreme Southwest and the West have been included in the lists, and the chief range of each has been noted. An effort has been made to indicate by the type the relative importance of the plants as pollen and honey producers.

NORTH AND NORTHEAST.

[Above 40° N.]

Red or Soft Maple (<i>Acer rubrum</i>).....	April.
Alders (<i>Alnus</i>).....	April.
Elm (<i>Ulmus</i>).....	April.
Willows (<i>Salix</i>).....	Apr.-May.
Dandelion (<i>Taraxacum taraxacum</i> = <i>T. officinale</i> of Gray's Manual).....	Apr.-May.
Sugar, Rock, or Hard Maple (<i>Acer saccharum</i> = <i>A. saccharinum</i> of Gray's Manual).....	Apr.-May.
Juneberry, or Service Berry (<i>Amelanchier canadensis</i>).....	May.
Wild Crab Apples (<i>Pyrus</i>).....	May.
GOOSEBERRY and CURRANT (<i>Ribes</i>).....	May.
PEACH, CHERRY, and PLUM (<i>Prunus</i>).....	May.
PEAR and APPLE (<i>Pyrus</i>).....	May.
Huckleberries and Blueberries (<i>Gaylussacia</i> and <i>Vaccinium</i>).....	May-June.
COMMON, BLACK, or YELLOW LOCUST (<i>Robinia pseudacacia</i>).....	May-June.
European Horse-chestnut (<i>Æsculus hippocastanum</i>).....	May-June.
Common Barberry (<i>Berberis vulgaris</i>).....	May-June.
TULIP TREE, or "WHITEWOOD" (<i>Liriodendron tulipifera</i>).....	May-June.
Grapevines (<i>Vitis</i>).....	May-June.
Rape (<i>Brassica napus</i>).....	May-June.

<i>White Mustard</i> and <i>Black Mustard</i> (<i>Brassica alba</i> and <i>B. nigra</i>)	June.
RASPBERRY (<i>Rubus</i>)	June.
WHITE CLOVER (<i>Trifolium repens</i>)	June-July.
ALSIKE CLOVER (<i>Trifolium hybridum</i>)	June-July.
Edible Chestnut (<i>Castanea dentata</i> = <i>C. sativa</i> var. <i>americana</i> of Gray's Manual)	June-July.
ALFALFA, or LUCERN (<i>Medicago sativa</i>)	June-July.
LINDEN, or BASSWOOD (<i>Tilia americana</i>)	July.
Smooth Sumac (<i>Rhus glabra</i>)	July.
Buttonbush (<i>Cephalanthus occidentalis</i>)	July.
MELILOT, BOKHARA, or SWEET CLOVER (<i>Melilotus alba</i>)	July-Aug.
Indian Corn (<i>Zea mays</i>)	July-Aug.
Melon, Cucumber, Squash, Pumpkin (<i>Citrullus</i> , <i>Cucumis</i> , and <i>Cucurbita</i>)	July-Aug.
Fireweed (<i>Erechtithes hieracifolia</i>)	July-Sept.
Chicory (<i>Cichorium intybus</i>)	July-Sept.
GREAT WILLOW-HERB (<i>Epilobium angustifolium</i>)	July-Aug.
KNOTWEEDS (<i>Polygonum</i> , especially <i>P. pennsylvanicum</i> and <i>P. persicaria</i>)	Aug.-Sept.
BUCKWHEAT (<i>Fagopyrum fagopyrum</i> = <i>F. esculentum</i> of Gray's Manual)	Aug.-Sept.
Indian Currant, or Coral Berry (<i>Symphoricarpos symphoricarpos</i> = <i>S. vulgaris</i> of Gray's Manual)	Aug.-Sept.
Thoroughwort, or Boneset (<i>Eupatorium perfoliatum</i>)	Aug.-Sept.
<i>Bur Marigolds</i> (<i>Bidens</i> , especially SPANISH NEEDLES, <i>Bidens bipinnata</i>)	Aug.-Oct.
Wild Asters (<i>Aster</i>)	Aug.-Oct.
GOLDEN-RODS (<i>Solidago</i>)	Aug.-Oct.

MIDDLE SECTION.

[Between 35° and 40° N.]

Redbud (<i>Cercis canadensis</i>)	Mar.-Apr.
Alder (<i>Alnus rugosa</i> = <i>A. serrulata</i> of Gray's Manual)	Mar.-Apr.
Red or Soft Maple (<i>Acer rubrum</i>)	Mar.-Apr.
Elm (<i>Ulmus</i>)	Mar.-Apr.
Willows (<i>Salix</i>)	Mar.-May.
Dandelion (<i>Taraxacum taraxacum</i> = <i>T. officinale</i> of Gray's Manual)	Apr.-May.
Apricot (<i>Prunus armeniaca</i>)	Apr.-May.
Juneberry or Service Berry (<i>Amelanchier canadensis</i>)	Apr.-May.
Wild Crab Apples (<i>Pyrus</i>)	Apr.-May.
Gooseberry and Currant (<i>Ribes</i>)	Apr.-May.
Rhododendrons (<i>Rhododendron</i>)	Apr.-May.
Peach, Cherry, and Plum (<i>Prunus</i>)	Apr.-May.
Pear and Apple (<i>Pyrus</i>)	Apr.-May.
CRIMSON CLOVER (<i>Trifolium incarnatum</i>)	Apr.-May.
Huckleberries and Blueberries (<i>Gaylussacia</i> and <i>Vaccinium</i>)	May.
American Holly (<i>Ilex opaca</i>)	May.
Black Gum, Sour Gum, Tupelo or Pepperidge (<i>Nyssa aquatica</i> = <i>N. sylvatica</i> of Gray's Manual)	May.
Manzanitas (<i>Arctostaphylos</i>) (California)	May.
COMMON, BLACK, or YELLOW LOCUST (<i>Robinia pseudacacia</i>)	May.
Barberry (<i>Berberis canadensis</i>)	May.
TULIP TREE, or "POPLAR" (<i>Liriodendron tulipifera</i>)	May.
Mountain Laurel (<i>Kalmia latifolia</i>)	May-June.
Grapevines (<i>Vitis</i>)	May-June.
Persimmon (<i>Diospyros virginiana</i>)	May-June.
WHITE CLOVER (<i>Trifolium repens</i>)	May-June.
Alsike Clover (<i>Trifolium hybridum</i>)	May-June.
RASPBERRY (<i>Rubus</i>)	May-June.

COWPEA (<i>Vigna sinensis</i>)	May-Aug.
EDIBLE CHESTNUT (<i>Castanea dentata</i> = <i>C. sativa</i> var. <i>americana</i> of Gray's Manual)	June.
Chinquapin (<i>Castanea pumila</i>)	June.
Catalpas, or Indian Bean Trees (<i>Catalpa</i>)	June.
MAGNOLIA, or SWEET BAY (<i>Magnolia glauca</i>)	June.
LINDEN, or "LINN" (<i>Tilia americana</i> and <i>T. heterophylla</i>)	June.
SOURWOOD, or SORREL TREE (<i>Oxydendrum arboreum</i>)	June-July.
Oreye Daisy, or Whiteweed (<i>Chrysanthemum leucanthemum</i>)	June-July.
ALFALFA (<i>Medicago sativa</i>) (West)	June-Aug.
MELILOT, BOKHARA, or SWEET CLOVER (<i>Melilotus alba</i>)	June-Aug.
Smooth Sumac (<i>Rhus glabra</i>)	July.
Buttonbush (<i>Cephalanthus occidentalis</i>)	July.
CLEOME, or "ROCKY MOUNTAIN BEE PLANT" (<i>Cleome serrulata</i> = <i>C. integrifolia</i> of Gray's Manual) (West)	July-Aug.
Indian Corn (<i>Zea mays</i>)	July-Aug.
Cucumber, Melon, Squash, Pumpkin (<i>Cucumis, Citrullus, and Cucurbita</i>)	July-Aug.
Knotweeds (<i>Polygonum</i> , especially <i>P. pennsylvanicum</i> and <i>P. persicaria</i>)	July-Sept.
Buckwheat (<i>Fagopyrum fagopyrum</i> = <i>F. esculentum</i> of Gray's Manual)	Aug.-Sept.
Wild Asters (<i>Aster</i> , especially HEATH-LIKE ASTER, <i>Aster ericoides</i>)	Aug.-Oct.
Thoroughwort, or Boneset (<i>Eupatorium perfoliatum</i>)	Aug.-Oct.
Bur Marigolds (<i>Bidens</i> , especially SPANISH NEEDLES, <i>Bidens bipinnata</i>)	Aug.-Oct.
Golden-rods (<i>Solidago</i>)	Aug.-Oct.

SOUTH.

[Below 35° N.]

Redbud (<i>Cercis canadensis</i>)	Feb.-Mar.
Alder (<i>Alnus rugosa</i> = <i>A. serrulata</i> of Gray's Manual)	Feb.-Mar.
Red or Soft Maple (<i>Acer rubrum</i>)	Feb.-Mar.
Elm (<i>Ulmus</i>)	Feb.-Mar.
Willows (<i>Salix</i>)	Feb.-Mar.
Dandelion (<i>Taraxacum taraxacum</i> = <i>T. officinale</i> of Gray's Manual)	Feb.-Mar.
Apricot (<i>Prunus armeniaca</i>)	Feb.-Mar.
WILD PENNYROYAL (<i>Hedeoma pulegioides</i>)	Feb.-Mar.
Carolina Cherry, or Laurel Cherry (<i>Prunus caroliniana</i>)	March.
Juneberry, or Service Berry (<i>Amelanchier canadensis</i>)	March.
ORANGE and Lemon (<i>Citrus</i>)	Mar.-Apr.
Cottonwoods, or Poplars (<i>Populus</i>)	Mar.-Apr.
TIH (<i>Cliftonia monophylla</i>) (Florida and southern Georgia, westward)	Mar.-Apr.
Gooseberry and Currant (<i>Ribes</i>)	Mar.-Apr.
Peach, Cherry, and Plum (<i>Prunus</i>)	Mar.-Apr.
Pear and Apple (<i>Pyrus</i>)	Mar.-Apr.
Huckleberries and Blueberries (<i>Gaylussacia</i> and <i>Vaccinium</i>)	April.
Crimson Clover (<i>Trifolium incarnatum</i>)	April.
BLACK GUM, SOUR GUM, TUPELO, or PEPPERIDGE (<i>Nyssa aquatica</i> = <i>N. sylvatica</i> of Gray's Manual)	April.
BALL, or BLACK SAGE (<i>Ramona stachyoides, R. palmeri, etc.</i> = <i>Audibertia stachyoides, etc.</i> of the Botany of California) (California)	April.
GALLBERRY, or HOLLY (<i>Ilex glabra</i>)	Apr.-May.
Manzanitas (<i>Arctostaphylos</i>) (California)	Apr.-May.
Acacias (<i>Acacia</i>)	Apr.-May.
Common, Black, or Yellow Locust (<i>Robinia pseudacacia</i>)	Apr.-May.
Persimmon (<i>Diospyros virginiana</i>)	Apr.-May.
EDIBLE CHESTNUT (<i>Castanea dentata</i> = <i>C. sativa</i> var. <i>americana</i> of Gray's Manual)	Apr.-May.

Chinquapin (<i>Castanea pumila</i>).....	Apr.-May.
Catalpas (<i>Catalpa</i>)	Apr.-May.
MAGNOLIAS (<i>Magnolia</i>)	Apr.-May.
Rhododendrons, Rosebays, Azaleas (<i>Rhododendron</i>).....	Apr.-May-June.
MESQUITE (<i>Prosopis juliflora</i>) (Texas and westward).....	Apr.-July.
<i>Cowpea</i> (<i>Vigna sinensis</i>).....	Apr.-Aug.
TULIP TREE, or "POPLAR," (<i>Liriodendron tulipifera</i>)	May.
Mountain Laurel (<i>Kalmia latifolia</i>)	May.
Grapevines (<i>Vitis</i>)	May.
Raspberry (<i>Rubus</i>)	May.
China Berry, China Tree, or Pride of India (<i>Melia azedarach</i>).....	May.
WHITE SAGE (<i>Ramona polystachya</i> = <i>Audibertia polystachya</i> of the Botany of California) (California).....	May-June.
SOURWOOD, or SORREL TREE (<i>Oxydendrum arboreum</i>).....	May-June.
SAW PALMETTO (<i>Serenoa serrulata</i>) (coasts of Georgia and Florida).....	May-June.
HORSEMINT (<i>Monarda citriodora</i>)	May-July.
BANANA (<i>Musa sapientum</i>)	May-Sept.
LINDEN, or "LINN" (<i>Tilia americana</i> , <i>T. pubescens</i> , and <i>T. heterophylla</i>)	June.
Red Bay (<i>Persea borbonia</i> = <i>P. carolinensis</i> of Gray's Manual).....	June.
Indian Corn (<i>Zea mays</i>).....	June-July.
Cucumber, Melon, Squash, Pumpkin (<i>Cucumis</i> , <i>Citrullus</i> , and <i>Cucurbita</i>).....	June-July.
BLACKWOOD or BLACK MANGROVE (<i>Arcennia nitida</i>) (Florida)	June-July.
ALFALFA (<i>Medicago sativa</i>).....	June-Aug.
MELILOT, BOKHARA, or SWEET CLOVER (<i>Melilotus alba</i>).....	June-Aug.
COTTON (<i>Gossypium herbaceum</i>)	June-Aug.
WILD BUCKWHEAT (<i>Eriogonum fasciculatum</i>) (California).....	June-Oct.
CABBAGE PALMETTO (<i>Sabal palmetto</i>) (coasts of South Carolina, Georgia, and Florida)	July-Aug.
Japan or Bush Clover (<i>Lespedeza striata</i>).....	Aug.-Sept.
Bur Marigolds (<i>Bidens</i> , especially <i>Spanish Needles</i> , <i>Bidens bipinnata</i>).....	Aug.-frost.
Wild Asters (<i>Aster</i> , especially HEATH-LIKE ASTER, <i>Aster ericoides</i>)	Aug.-frost.
Golden-rods (<i>Solidago</i>).....	Aug.-frost.
BLUE GUM and RED GUM (<i>Eucalyptus globulus</i> and <i>E. rostrata</i>) (California).....	Dec.-Mar.

CHAPTER VII.

SPRING MANIPULATION.

The first examination in the spring should be mainly for the purpose of ascertaining whether or not the honey stores have been exhausted. It should be early, and hence not so extended as to risk the loss of much warmth from the brood apartment. Merely lifting one edge of the quilt or, if the bottom board is a loose one, tipping the hive back so as to get a view in between the combs will often suffice. Should there not be at least the equivalent of two full frames of honey it is best to supply the deficiency at once. Without disturbing the brood full combs may be substituted at each side for the empty ones. If combs stored with honey and sealed over are not in reserve liquid honey or sugar sirup may be poured into empty ones and placed in the hives at night. A less dauby plan is to use one or more feeders directly over the brood nest, supplying several pounds of food at once. An excellent way is to give at one time all they need in the shape of a cake of bee candy, made by mixing fine sugar with just enough honey to produce a stiff dough. This cake of candy should be wrapped in heavy paper (half parchment, or such as is used for wrapping butter is good) and laid on top of the frames, after having punctured the paper in several places with a pencil or sharp stick to give the bees ready access. Two or three twigs or strips of wood laid across the frames before the cake is placed on them will also give the bees a better opportunity to reach the food.

If the food be given in small quantities brood rearing will be encouraged and still greater supplies of food will be called for, rendering it absolutely necessary to give a large amount at once or continue the feeding until natural sources fully supply the needs of the bees and brood, otherwise both may starve. Three pounds of sugar dissolved in one quart of water will make a suitable sirup for spring feeding. Dry sugar may be used instead of sirup. The bees will liquify it themselves if they have access to water. For stimulative purposes honey is better than sugar, "strained honey" being better than extracted. This is because of the greater amount of pollen which the strained product contains, the pollen being highly nitrogenous, hence capable of building up muscular tissue. But if the liquid honey is one-half more in price per pound than sugar the latter would doubtless be the more economical, certainly so if a plentiful supply of good pollen in the combs or fresh from the fields can be had. Rye flour put in sunny places and sprinkled with honey to attract the bees will be collected until new pollen comes.

When the weather has become sufficiently settled to render safe the inspection of the brood combs, or, in general, when the bees fly

the greater part of each clear day, the work of the queen may be inspected. Should the comb having the largest area of brood in it be toward one side of the hive it is best to locate it as near the center as may be, placing on either side successively those combs having smaller circles of brood and on each side of these the combs containing no brood, but well stored with pollen, while those having honey only will come still outside of these. The brood nest will then have an opportunity to develop equally in all directions. Empty combs are of little use at this time outside of the brood nest as thus arranged, and should be replaced by combs of honey if the latter is needed, or removed altogether. If the combs are well crowded with bees and the queen shows by her regular and compact placing of the brood, as well as by the quantity she seems to have, that she is vigorous and thus capable of accomplishing more than any ordinary brood nest will require of her at this time of the year, a frame filled with worker comb may be slipped into the center of the brood nest. This will be taken possession of immediately by the bees, cleaned and warmed up, whereupon the queen will soon have it filled with eggs. From time to time other combs may be added in the same manner. If cautiously and judiciously followed this plan, supplemented by liberal stores, will increase the brood area and eventually the population of the hive. But the utmost caution is needed, for if done too early cool weather may cause the bees to cluster more closely and result in the chilling of some part of the brood which has thus been spread. The very object sought is not only missed, but the loss of brood will prove a serious setback to the colony. The escape of any of the warmth generated by the bees, as also sudden changes in the weather, should be guarded against. Warm covering above and outer protection are therefore absolute necessities if the best results are to be attained. With favorable weather for the development of brood it is certain that stimulative feeding, if made necessary by the fact that the natural honey resources of the country will not alone bring the strength of the colony fairly up to the desired standard by the opening of the harvest, is to be begun six to seven weeks before the opening of the honey flow from which surplus is to be expected.

If, however, this honey flow comes so early that it is likely to be preceded by weather unfavorable to the development of brood, it will be necessary to allow for this by beginning the stimulation even earlier, so that it may be done more gradually, and the greatest care will have to be taken to retain all the heat of the brood nest. Should the main flow be preceded by a lighter one, especially if the latter comes some weeks before the chief harvest, it may be important to watch the brood nest closely lest it becomes clogged with honey to the exclusion of brood, inclining the bees not to enter surplus receptacles placed above and causing the colony to be weak in numbers later in the season. This state of affairs can be easily avoided by the timely use of the honey extractor, since the brood combs, emptied of the honey which the

workers in an emergency have stored wherever they found vacant cells, are made available for the queen. Before the main harvest opens it may even be necessary in order to keep the combs filled with brood to feed **back** gradually this extracted honey or its equivalent; but by taking it away and returning it gradually the object sought will have been accomplished, namely, keeping the combs stocked with brood until the harvest is well under way, or as long as the larger population thus gained in the hive can be made available.

It is in this getting workers ready for the early harvest—hives overflowing, as it were, with bees—that the skill of the apiarist is taxed to its utmost. The work properly begins with the close of the summer preceding the harvest, for the first steps toward successful wintering should be taken then, and unless wintered successfully the colony can not be put in shape to take full advantage of an early honey harvest.

Good judgment in the application of the hints given in this chapter, with careful and frequent attention, will bring colonies to the chief spring or early summer flow of honey in good condition, with plenty of bees and with combs well stocked with brood, provided they have wintered well and have good queens.

TRANSFERRING.

If colonies have been purchased in box hives, it is advisable at the first favorable opportunity to get them into frame hives.

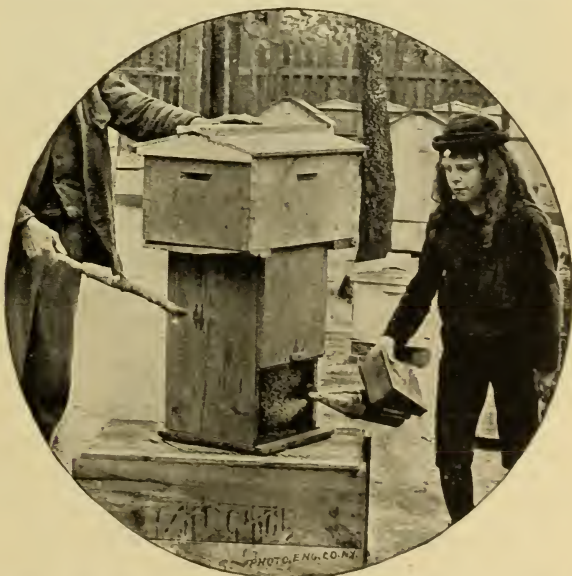

FIG. 53.—Transferring—drumming the bees from a box hive into a frame hive. (Original.)

Early in the season—that is, in April or May in middle latitudes, before the brood nest has reached its greatest extension and while the hive contains the least honey—it is not a difficult matter to drive the

bees from their combs, cut out the latter, and fit them into frames. If the combs thus fitted in are held temporarily in place in the frames, the bees, under whose care they should be placed at once, will fasten them securely in a few hours or days at most. To drive the bees from the box hive proceed as follows: Toward the middle of a pleasant day blow smoke into the hive to be transferred, and after the bees have been given a few minutes in which to lap up their fill of honey, invert the hive and place over the open end an empty box, or the frame hive itself, making whichever is used fit closely on the hive (fig. 53). By rapping continuously for some minutes on the hive the bees will be impelled to leave it and cluster in the upper box. A loud humming will denote that they are moving. The hive thus vacated may then be taken into a closed room and one side pried off to facilitate the removal of the combs. The box containing the bees is to be placed meanwhile on the spot originally occupied by the box hive, the bees being allowed to go in and out without restraint, only two precautions being necessary, namely, to shade the box well and provide for ventilation by propping it up from the bottom, leaving also, if possible, an opening at the top. When the combs have been fitted into frames, the hive containing them is placed on the original stand and the bees shaken from the box in front of it.

In filling the frames with combs cut from a box hive, the largest and straightest sheets having the most sealed worker brood in them should be selected first and so cut that the frame will slip over them snugly, taking pains, as far as possible, to have the comb placed in the frame in the same position in which it was built, since most of the cells, instead of being horizontal, are inclined upward, the inclination of the deeper store cells being greatest. The comb, if not heavy, can be held in place temporarily by slender wire nails pushed through holes punched in the side and top bars. Before the introduction of wire nails the writer used long thorns pulled from thorn-apple trees, which served the purpose very well. In the case of combs heavy with honey or brood or pieced more or less it will be safer to use, in addition to a few wire nails, a pair or two of transferring sticks. These are simply slender strips of wood slightly longer than the depth of the frame and notched at each end. By placing such a stick on either side of the comb and winding annealed wire around the top and bottom ends so as to draw the sticks firmly against the surface of the combs the latter will be held securely in the frames. The midrib between the rows of cells should be pressed neither to one side nor the other; thus, if cells on one side are deeper than those on the other, they should be shaved down, unless the honey will be cut into too much, in which case the comb may be allowed to project on one side until it has been fastened in the frame and the hive has been generally put in order by the bees, the point being not to force them to try to manage too much running honey at one time, lest robbing be induced. In many instances the comb when pressed into the frame will seem to

be so firm as not to need nails or sticks, but in the heat of the hive, and with the weight of the bees that will cluster on it to repair the cut edges and fasten them to the bars of the frame, unsupported combs are very apt to give way, creating disastrous confusion. Thus the sticks, nails, or their equivalent should always be used (fig. 54). All frames should be filled with perfectly straight combs so as to be interchangeable. With care in fitting in and some trimming and pressing into shape afterwards, fully three-fourths of the worker combs cut from box hives can be made into good, serviceable combs in frame hives. The process is much facilitated if such combs are used in the extractor during the first season or two after transferring.

Should the time be near the swarming season the combs will be so filled with brood and honey that the task will be much greater, and the transfer should be postponed until three weeks after the first swarm issues. The brood left by the old queen will have matured and issued from the cells by that time, and the young queen, if no accident has

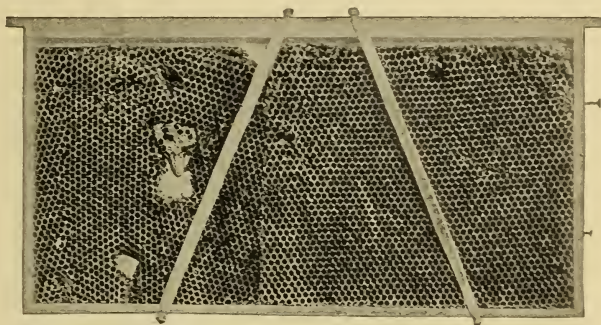

FIG. 54.—Transferred comb and inserted queen cell. (Original.)

happened to her, will have begun laying; yet there will usually be only eggs, with perhaps a few very young larvæ, present in the combs at this time, so that the cutting out and fitting of the latter into frames will not be as troublesome nor attended with so much waste as just before the swarm issued.

Still another plan—one which it would not be best to employ before fairly warm weather has set in, but which will render the work of transferring the lightest—is to turn the box hive bottom upward and place on it the brood apartment of a frame hive, having in it frames filled with worker combs or with comb foundation, arranging at the same time to give the bees ready access from their combs to those above and no entrance to their hive except through the frame hive above. This can easily be done by making a temporary bottom board for the frame hive, with several holes through it, or with one large one about the size of the open end of the box hive. As soon as it is perceived that the queen has taken possession of the new combs—as she will be

almost certain to do, especially if one of the combs placed above contains some brood—a piece of queen-excluding zinc placed over the opening between the two hives will keep her above, and three weeks later, when all the brood in the combs below has matured, the box hive may be removed and the combs transferred to frames, if worth using in this way; but if old or composed of drone cells or very irregular in shape these combs may be rendered into wax, after extracting any honey that may happen to be in them. Inverting the box hive will generally cause the bees to remove what honey they have stored in the combs. This honey will be utilized in building out the foundation placed in the added story, or, having these combs completed, the bees will store in them whatever remains. Should the queen fail to enter the superposed hive, the plan may be adopted of driving her with her workers into the added story, as described on page 72. When the lower combs have been nearly deserted it will be safe to assume that the queen has gone into the upper hive with the main force of workers, and the excluder zinc may be inserted.

QUEENLESSNESS IN SPRING.

The loss of a queen during winter or early spring can generally be discovered by noticing just at nightfall, after the first or second general flight, which colonies are restless and continue to buzz excitedly when the others are humming in a contented manner or have quieted down for the night. The workers of the queenless colony run in and out excitedly, searching over the front of the hive. Should it be opened they will not resent the intrusion, but, remaining on the combs, will at once set up a loud and prolonged buzzing. These symptoms become less pronounced from day to day. If a comb containing brood be inserted during this period it will be hailed with evident delight, manifested by the eager crowding of the bees from all sides toward it. A contented hum replaces the sound of mourning, and if young worker-larvæ are present preparations, as described on pages 88–89, are begun at once to rear a queen. However, if much reduced in numbers the colony should be joined to one with a queen, or several queenless ones united. The latter may be smoked and simply shaken or brushed together. But bees that have been queenless long when added to those that have not yet missed their own queen will frequently be killed at once. The queen should therefore be taken from her own bees and caged for thirty-six to forty-eight hours in the hive which has previously been queenless, and her own bees added when she is released. (See page 94.) A board leaned against the front of the hive will cause the bees to note their change in location when they fly out and they will then easily find their new quarters when returning from their flight.

CHAPTER VIII.

SECURING SURPLUS HONEY AND WAX.

If the colonies of bees have been brought to the opening of a given honey flow with a powerful population recently hatched it will require no great skill to secure a good crop, granted, of course, that the flowers actually do secrete the nectar. In the ordinary course of events some colonies are likely to come through to the early harvest in good shape, but if all those contained in a large apiary are in prime order at this time it is good evidence of skill on the part of the attendant, this even though the weather and other circumstances may have favored his work. To secure a yield of surplus honey the part remaining to be done, if all goes well, is merely to put the surplus receptacles in place, admit the bees, and remove the combs when filled and sealed. But if swarming complications arise the whole of the bee keeper's skill and ingenuity may again be called into requisition to keep the forces together and storing in the surplus receptacles. Should the expected harvest not come—that is, should the flowers from which the yield is anticipated not secrete honey, or should they bloom when the weather would not permit the bees to fly—of course no amount of skill could make up the deficiency. In such a case all that can be done is to carry the colonies through to the next honey yield in good shape—to keep up (by feeding if necessary) the populousness of the colonies. The flow may begin suddenly or before it is looked for; it may be excellent for only a very short time, a day or two even, and be cut off short in the midst of its greatest abundance. Thus the skill lies in having the colonies ready for whatever may come and a force sufficient to store the whole season's surplus in a few days.

EXTRACTED HONEY.

One of the most important points in securing extracted honey is to have a large stock of surplus combs. These, with the strong colonies of bees to utilize them, and the honey extractor, are the great requisites of the producer of extracted honey. As fast as the bees can cover and utilize them, these combs are added to the colonies, one or two at a time from the opening of the season until the brood apartment is full. As soon as more combs than the lower story will hold are needed a second story filled with combs may be added, or but two or three may be placed in it at one side with a division board next to them. It is a good plan to sort over the combs of the brood apartment, removing several of the

less regular ones, or if all are alike as regards regularity and in having worker cells only, but some contain considerable honey and little brood, these are to be removed and the empty space filled in with good worker combs. The removed combs should be placed in the top story, which, if the weather and the strength of the colony permit, is to be filled out with combs at once. The strongest colonies will, of course, begin work first, and can often spare partly filled combs to be placed in the top stories of less populous colonies, thus encouraging the latter to begin work in the upper stories. It is safe to say that in general more than twice the yield of honey can be obtained from colonies supplied during the whole honey flow, with all the completed combs they are able to utilize, than can be expected from colonies that have to build all of the combs for their surplus while stringing. Completed combs not being available, comb foundation in full sheets should be employed. During the early part of the harvest this will be drawn out very quickly and aid greatly in securing the honey which otherwise might be lost for want of store combs as fast as might be needed. During a fair yield the foundation will pay for itself the first season in the extra amount of honey, and the combs, properly cared for, can be used year after year—indefinitely, in fact—for extracting. The best of them should be picked out constantly to replace less desirable ones that may be found in the brood apartment, or to give to new swarms destined to produce extracted honey. Some prefer for the surplus cases frames half the depth of ordinary brood frames, finding them easier to manipulate.

Whenever the combs of a top story are nearly filled, and before they are completely sealed, it may be lifted up and another story, filled with empty combs, placed between it and the brood apartment, and this may be continued until the end of the honey flow, and all may be left on the hive during the warm weather. It would, of course, be easier to add the new stories successively at the top—that is, above the partially filled surplus stories—and this plan works well as long as the honey flow is abundant, but when put on just as the yield slackens, even if but little, or when the weather is cool, the bees may refuse to begin work in the new super unless it is placed between the partially filled ones and the brood apartment. Leaving the filled top stories on the hives for some time permits the more complete evaporation of the moisture contained in the newly gathered honey, and by marking the stories the honey from a certain source, when the yield has been sufficient to get the combs filled and sealed, can be extracted by itself. If the supply of combs is insufficient to hold the whole amount gathered, it must then be extracted as fast as sealed, lest the bees, lacking ready cells in which to deposit their surplus as fast as gathered, hang idly about, or if space for new combs exists, only slowly provide these, losing meanwhile much of the harvest. When sealed the honey will generally be found fairly ripened, though it may improve by being stored in open buckets or cans in a dry, warm room.

The process of extracting is extremely simple, and a little practice will enable an observing person to do it well (fig. 55). As indicated above, some judgment is required in the selection of combs, regard being had to the future condition of the colony. The filled combs, as fast as removed, are placed in a light case the size of a hive, or a tin can made specially for the purpose, covered closely to prevent the access



FIG. 55.—Uncapping and extracting honey. (Original.)

of robbers, and taken to the extracting room, which should be bee-proof. It is not always necessary to use such care in excluding all bees, but the novice should practice it until he learns to distinguish by the actions of the bees when such precautions may be dispensed with. Whenever possible the stories containing surplus honey should be lifted up and honey boards containing bee escapes slipped between them and the

brood apartment early in the morning of the day before the extracting is to be done, in case the bees are still gathering, otherwise the night before will do. The combs will then be free from bees, or nearly so, when the operator wishes to remove them, and will contain no honey gathered within twenty-four hours, the last day's gathering having also been ripened considerably during the night preceding the insertion of the escapes. When the queen has not been restricted in her laying to the lower story by means of excluders, this plan of freeing the combs of bees will fail in case the escapes are placed on lower stories above which the brood and the queen may be. The only way then will be to remove the combs one by one, after smoking the bees to quiet them, and shake or brush off the latter into the top story. Italians can not be shaken off unless their bodies are pretty well filled with honey, but they may be safely brushed off after smoking. For this a single large feather from the left wing of a turkey is best. Other races can be shaken off after smoking. Eastern bees should never be brushed from the combs when extracting, nor at any time unless they are gorged with honey. They can all be shaken off easily, and will need less smoke than the European races.

When much extracting is to be done, top stories of hives or light cases with cloth covers, weighted with a rod sewed into the loose edge, may be used to hold the full combs as fast as taken from the hives, and these, placed on a wheelbarrow, cart, or car, can be easily transported to the extracting room. The uncapping knife, kept in hot water when not in use, is passed rapidly under the capping of the sealed combs, the point of it being used to reach depressed surfaces. The loosened cappings drop into a sieve resting over a pan, or into the upper part of a can specially designed to receive cappings. The small amount of honey removed with the cappings drains through the strainer and is drawn off below. The uncapped combs are placed in the extractor at once. As the cells generally slant upward more or less, especially those built for store cells outside the brood nest, the throwing out of the honey is facilitated by placing each comb in such a manner as to bring the top bar at the right hand, the basket being revolved in the most natural way—that is, from right to left. A little practice will enable the operator to note the speed required in order to free the combs entirely from honey, which will depend, of course, upon the consistency of the honey and the length of time combs are revolved. While it is, in general, best to avoid extracting from combs containing brood, cases will arise where it is necessary. If the brood is sealed, there will be less liability of injuring it than when open cells containing larvæ are placed in the extractor; but a moderate degree of speed continued somewhat longer will usually bring the honey out without disturbance to the immature bees. Three persons can work together very advantageously—one to remove the surplus cases or combs from the hives, free them of their bees, and bring them into the extracting room, where

two assistants uncap and extract the honey. If the bees are not gathering honey and are therefore prone to rob, the person who removes the combs from the hives should be assisted by an active boy who can cover hives or cases quickly or lift the latter when necessary. The combs when emptied may be returned at once to the hives if the bees are still engaged in storing. The slight damage which they have sustained under the uncapping knife or in the extractor will soon be repaired; indeed, with a little experience the uncappers will be able to smooth and trim irregular combs in such a way as to render them straighter after they have been through the extractor. It is particularly desirable, in order to straighten the combs of transferred colonies and get them in good working trim, that they be run for extracted honey during the first year or two; moreover, a good yield of extracted honey is more likely to be obtained from recently transferred colonies than comb honey, especially if the manipulators are beginners in the work.

When the extracting is done after the close of the gathering period, the greatest care should be taken not to start robbing. The surplus combs should be returned to the hives just before nightfall, and not even a taste of sweets of any kind should be left exposed. The object in returning the combs is to have them cleaned up, and also to have them under the protection of the bees until cool weather puts a stop to the destructive work of wax-moth larvæ. When sharp frosts occur, the surplus combs may be removed from the hives and placed in a dry, cold room. An open loft (if not infested with mice or if the combs are protected from the latter) is a good place, and it is much better to place the combs so they do not touch each other.

COMB HONEY.

The general directions given in the preceding chapter on spring manipulation to secure populous colonies apply as well to those designed for comb honey as to those which are to produce extracted honey. If any difference is to be observed it is even more important that the former be brought to the opening of the honey flow with the brood combs compactly filled with developing bees to the exclusion of honey, than that the latter should be so; and colonies not strong enough to enter sections readily, if at all, may still be utilized, and often do fairly well in the production of extracted honey.

The old-fashioned surplus boxes holding 25 to 30 pounds are regarded quite as relics of the past by those who use frame hives and produce comb honey in fine marketable shape, and even if for home consumption the pound (fig. 56) and 2-pound sections are always preferred, since they are so cheap, permit the use of comb foundation, and are in neat shape and of convenient size for the table.

Section holders (fig. 57) with sections folded and in place, each section supplied with thin foundation, preferably full sheets, but at least

guides, should be in readiness before the opening of the harvest. Forty to fifty sections for each hive should be prepared. One-piece sections, if bought in the flat, should be placed in the cellar for two or three days before folding. If the section back of the V-joints is then moistened slightly they can be set up rapidly without breakage. Sections made

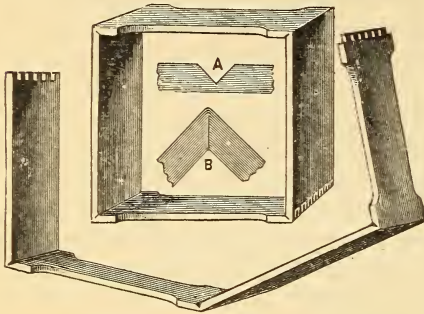

FIG. 56.—One-piece V-grooved sections. (From Gleanings.)

of white poplar are by far the neatest looking and do not cost much if any more than bass-

wood, so that bee keepers might show their disapproval of the wholesale destruction of our basswood or linden timber by resolutely refusing to buy sections made of that wood. The four-piece sections, if well made, are preferable to the one-piece. The latter do not keep their shape as firmly as the

four-piece sections, which are made with lock joints at all the corners.

The foundation for sections should be the quality known as "thin surplus," or, preferably, if full sheets be used, "extra-thin surplus." These grades are made of selected, light-colored wax, and 1 pound furnishes full sheets for 100 to 125 standard sections ($4\frac{1}{4}$ by $4\frac{1}{4}$ inches). The sheets should be cut no larger than $3\frac{3}{4}$ inches square. These will take up about three-sixteenths of an inch in fastening, which will leave nearly one-half inch space between the lower edge and the bottom piece of the section and allow the foundation to stretch while being drawn out. This is necessary, otherwise the partially completed comb will bulge as soon as it reaches the bottom of the section. In cutting foundation either for sections or frames one edge—the one to be attached—should be perfectly straight. To secure this not more than six to ten sheets (depending on their thickness) should be laid in one pile, and a sharp, thin-bladed knife, as well as a straight rule, used. Two or three piles may be laid side by side and with a rule long enough to reach across them all a dozen to thirty sheets can be cut at a time. Dipping the knife in warm water facilitates the work.

The sheets are fastened in the section by the use of one of the machines mentioned on page 52. They secure the wax to the wood by

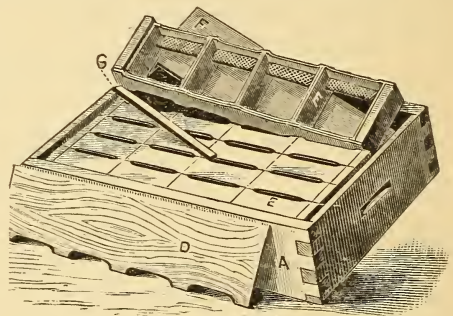

FIG. 57.—Super with sections and section holders in place: A, super; D, separator; E, sections; F, follower; G, wedge. (From Gleanings.)

of white poplar are by far the neatest looking and do not cost much if any more than bass-

wood, so that bee keepers might show their disapproval of the wholesale destruction of our basswood or linden timber by resolutely refusing to buy sections made of that wood. The four-piece sections, if well made, are preferable to the one-piece. The latter do not keep their shape as firmly as the

pressure combined in some instances with heat. Fig. 40 shows one of these. The simplest form consists merely of a sliding lever hinged to a block. It is intended to be fastened by means of screws to a table or bench, and is then ready for use when the lever is moistened with honey, starch water, or soapsuds along the edge which is to touch the wax sheets. The foundation is laid flat on the top piece of the section in such a way that the straight edge passes the center line one-eighth of an inch, and the whole is then slipped under the lever. The latter is brought down with a sliding motion toward the operator and at the same time the foundation is bent up at right angles to the top piece. If the wax is slightly soft it will adhere firmly. A heated brick placed before the pile of starters will keep the edges soft enough if the work is done in a moderately warm room.

Starters half to three-fourths inch in width are sometimes used at the bottoms of sections to secure firm attachment of combs there. Bees incline to gnaw these bottom starters away unless the top pieces of foundation reach within one-half inch of them. Top starters an inch or less in width may be used alone as comb guides when it is desirable to avoid great outlay for foundation.

The use of strips of tin or wood as separators (fig. 57, D) between the sections insures straight combs with smooth surfaces, thus convenient to handle and ship.

The sections furnished with starters or full sheets of foundation are slipped with separators into supers and piled away ready for use as soon as the harvest opens.

PUTTING ON SECTIONS.

It is better not to put surplus honey receptacles on the hive until the honey flow actually begins, as, of course, no work will be done in them until then. Moreover, all the heat is needed in the brood apartment during the early part of the season. The bees might also become discouraged by the large amount of empty space and might not begin work in it at all before swarming. The sections would also be soiled by the bees crawling over them and daubing them with propolis.

The bee keeper who is familiar with the honey-producing flora of his locality will note the development of the flower buds of any plant from which he expects a crop and will be able to judge accurately by a glance at the colony when sections are needed. The beginner will do well to consult carefully the list of honey-producing plants given in the chapter on "Bee pasturage," and also endeavor by inquiry in his neighborhood to ascertain what other sources, if any, are within the reach of his bees. The usual time of blooming of all principal honey plants should be noted, and the management to secure populous colonies having been in accordance with the directions given in Chapter VII on "Spring manipulation," the opening of the first blossoms of any one of the important honey yielders should be the signal for placing supers with sections on all hives intended for comb-honey production. Should these indications not be sufficient, there is still another which no one

could mistake. It is to examine the tops of the brood combs from time to time and note when the store cells between the brood and the top bar are being made deeper by added wax. The fresh, whitened appearance which such combs present when viewed from above readily distinguishes them from the yellow or dark combs wholly built during previous seasons. The lower edges of partially completed combs will also show additions at the same time.

It having been determined that the time to put on sections has arrived, the quilt used over the frames is removed and the super, with section holders, sections, and separators in place, is set over the frames. A clean enameled or carriage-cloth quilt should be laid over the tops of the sections, if these are open above, and this weighted down with a board which has been clamped to prevent warping. At this time the

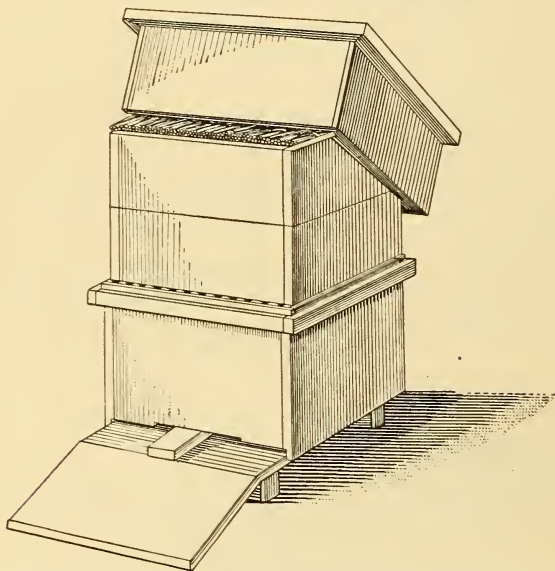

FIG. 58.—Dadant-Quinby form of Langstroth hive, elevated from bottom board and slid back for ventilation in summer. (Redrawn from Langstroth.)

flight hole should be full width and the hive protected from the direct rays of the sun during the hotter portions of the day. With small, single-walled hives, such as hold eight combs or less, it may be necessary, if the hives are crowded with bees, to raise them slightly from the bottom board or slide them back, so as to give small openings at the rear. Mr. Simmins's plan of placing below the brood nest a hive chamber with starters only in the frames permits the bees to avoid clustering too compactly and yet to keep up their work inside during extremely hot weather. Ventilation and shading of hives assist greatly toward the prevention of swarming, and having bred the colony up until it is sufficiently strong to take advantage of the harvest, and having reached the opening of that harvest, it is desirable by all means to keep the forces together as long as the flow lasts. (Fig. 58.)

The supers should be removed as fast as fairly filled. The bees are slow in sealing over the outside sections; therefore it is better not to lose time waiting for these to be completely capped, but replace the whole with a new set. Some prefer to lift up the super when about three-fourths completed and place the empty one below—that is, between it and the brood chamber.

The objection to this plan is that by the time the sections placed above have been fully completed they will have more or less propolis daubed on them and the combs will be considerably soiled by the bees running over them. A better plan to secure the completion of the outside sections is, after removing a number of supers, to select enough incomplete sections to fill one super, which is

then placed on a strong colony for completion, or the partly filled sections may be used in the middle of new supers as bait sections to induce the bees to cluster and begin work in them at once.

Notwithstanding such precautions for the prevention of swarming as shading the hives, ventilation, having only young queens, and the removal of the outside combs, substituting for them frames of foundations or starters near the center of the brood nest, swarms will sometimes issue, especially from hives devoted to comb-honey production. The best plan in this case is to hive the swarm in a clean new hive whose frames have been filled with starters and place this on the stand of the parent colony, moving the latter to a new position 6 or more feet away. The swarm in its new quarters will then be joined by the rest

of the field workers from the parent hive, and the whole force, reunited and having for some days no brood to care for, will constitute a strong colony for storing honey. The super of partly finished sections should be lifted, bees and all, from the parent hive and placed on the brood chamber of the new colony.

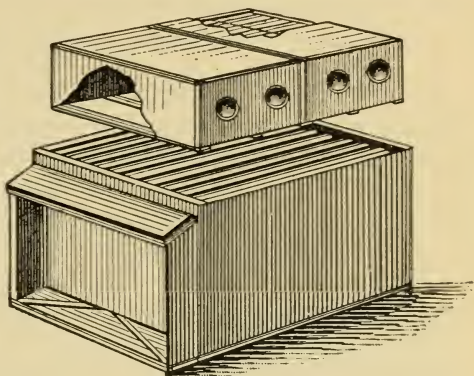

FIG. 59.—Langstroth hive with combined surplus case and shipping crate. (Original.)

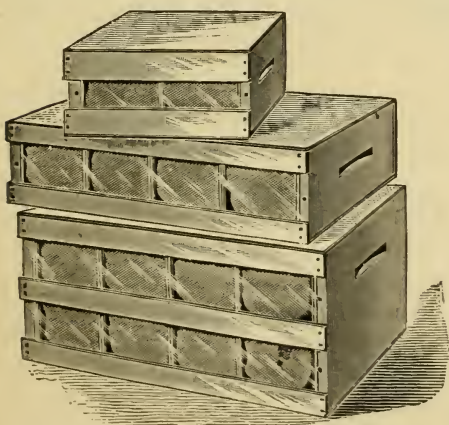

FIG. 60.—Honey shipping-cases. (From Gleanings.)

The supers should be promptly removed at the close of the honey harvest, honey boards with bee escapes in them being used to free them from bees, as described under the head of "Extracting." If the gathering season for the year has also ended, an examination of the brood apartment should be made to determine whether feeding is necessary, either to prolong brood rearing or for winter stores.

PRODUCTION OF WAX.

The progressive apiarist of the present time does not look upon the production of wax in so great a proportion compared with his honey yield as did the old-time box-hive bee keeper. The latter obtained much of his honey for the market by crushing the combs and straining it out, leaving the crushed combs to be melted up for their wax. Before the use of supers late swarms and many colonies quite heavy in honey were smothered by the use of sulphur; the light ones because their honey supply would not bring them through the winter, and the very heavy ones because of the rich yield in honey. Frequent losses of bees in wintering and through queenlessness gave more combs for melting, as without frame hives, honey extractors, or comb-foundation machines, the vacated combs were not often utilized again. The wax from the pressed combs was all marketed, since there could be but little home use for it.

The bee keeper of to-day, after having removed the honey from the combs by centrifugal force, returns them, but slightly injured, to be refilled by the bees, and at the end of the season these combs are stored away for use in successive years, or he secures the surplus, also apart from the brood, in neat sectional boxes, to be marketed as stored—that is, without cutting.

The wax must therefore come from the cappings of combs where extracted honey is produced, from occasional broken comb, bits of drone comb that are cut out to be replaced by worker comb, from unfinished and travel-stained sections from which the honey has been extracted, or from old brood combs that need to be replaced. Since the price per pound of extracted honey is usually not less than one-third and that of comb honey one-half the price of wax, and it has already been indicated (p. 28) that some 12 to 15 pounds of honey may in general be safely reckoned as necessary to produce 1 pound of comb, it can readily be seen that it is much more profitable to turn the working force, in so far as possible, to the production of honey rather than wax, taking only as much wax as can be produced without lowering the yield of honey; and what wax is taken is practically turned into honey the following year, for it is made into comb foundation, which, judiciously used, increases in turn the season's yield of honey.

Wax being so much more valuable than honey, it behooves the bee keeper to save even the smallest pieces of comb; but during warm weather they must not be left long or they will serve as breeding places

for the wax moth, unless fumigated with burning sulphur or exposed to the fumes of bisulphide of carbon two or three times each month until no more eggs of the moth remain.

The old way of rendering wax was to put the combs into a sack made of some open stuff, weight this down in a kettle of water, and boil for some time. The wax rose, and when cold was removed in a cake. This process, besides being dauby, often yielded inferior wax—burned, water-soaked, or filled with settlings.

The most approved method of rendering wax is, for moderate-sized apiaries at least, by means of the solar wax extractor (fig. 61), already mentioned under the head of "Implements." Its management is very simple. The machine is placed in the sunniest spot in or near the apiary, and all of the wax cappings, after having been drained of honey or worked over by the bees, as well as bits of comb, are thrown into the receiver above the wire strainer, the glass is adjusted, and the whole is turned so that the direct rays of the sun enter. More bits of comb are added from time to time during the day. The melted wax trickles through the strainer and collects in a tin placed at the lower edge of the tank or melter. The cake is removed each morning, it having cooled and contracted during the night sufficiently to cause the mass to cleave readily from the vessel.

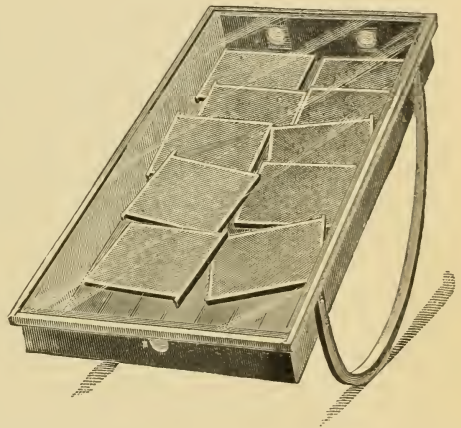

FIG. 61.—The Boardman solar wax extractor. (From Gleanings.)

The solar wax extractor can be used during four or five months of the year in the more northern States, and for a longer time in the South. To render wax at other times steam heat is best. When available a jet from a boiler may be connected with a barrel or vessel containing the combs and a large amount rendered in a short time. In smaller apiaries a steam extractor for use over a boiler on the stove may be employed (fig. 36). The manner of using these extractors is simple. The cappings and bits of comb to be rendered are placed in an inside basket made of perforated metal. Upon placing this over a water boiler, into which it fits closely, the steam rises through holes in the bottom of the upper can and readily penetrates the mass. The melted wax runs out through a spout at the lower edge of the upper can and is caught in a pan partly filled with warm water. As fast as the mass in the perforated can settles away more bits of comb are added. The dark residue remaining is composed of cocoons, pollen, and accidental impurities.

These may, however, contain considerable wax which they have absorbed as it melted. This waste may be avoided in a great measure if the combs are broken up and soaked in rain water for twenty-four hours before melting.

Cakes of wax, if designed for the comb-foundation manufacturer, will be acceptable just as they come from the wax extractor, but if for the general market they should all be remelted in order to purify them. This must be done with care or the wax will be seriously injured. Iron vessels will discolor it, and as well or spring water frequently contains iron, the use of rain water, whenever it is to come in contact with the melted wax, will be found more desirable. It is best to melt the wax slowly, for if heated too rapidly the particles become disaggregated and take up a certain quantity of water, the mass loses its luster, and becomes pale and granular. In this condition its market value is low. Remelting slowly, especially in a solar wax extractor, will restore it.

These difficulties in purifying wax may be avoided if it is melted in a tin or copper vessel and in a water bath, that is, the melter is to stand within a larger vessel containing sufficient water to surround the former. As much wax as possible should be melted at one time, and when convenient the inner can is left standing in the water, so that the wax remains liquid some time, permitting the impurities to settle. These may be shaved from the bottom of the cake and remelted if they contain much wax.

CHAPTER IX.

REARING AND INTRODUCING QUEENS.

So much of the bee keeper's success depends upon the strength of his colonies, and this in turn upon the character of the queens heading these colonies, that he needs to be well informed as to what constitutes a really good queen and how to produce such, and, having this knowledge, it will be profitable to be constantly on the alert to see that all colonies are supplied with the best queens procurable. With a queen from a poor strain of bees, or an unprolific one from a good strain, a colony, even in a season of abundant honey secretion, will give little or no return, while the seasons are not frequent during which one given a fair start and having a large, prolific queen of an active honey-producing strain can not collect a fair surplus beyond its own needs. Admitting this, it will be plain to all that queen bees differ proportionately in value as much as horses or cattle, and the keeper of bees who does not know how to select and produce the best can not be called a beemaster.

When bees swarm they generally leave a number of sealed queen cells in the parent colony. With blacks and Italians there are usually 6 to 10; rarely more than a dozen. Carniolans generally construct about two dozen, but under favorable conditions can be induced to build 75 to 100 good cells at a time. Fig. 62 represents a comb from a hive of Carniolans which had built at one time 70 queen cells. Cyprians usually make 30 or 40 queen cells, but may greatly exceed this number under the best conditions, while Syrians nearly always exceed it, sometimes even building as many as 200; and the writer has seen 350 cells constructed at one time by a single colony of bees in Tunis. It might be thought that where so many were constructed only a small proportion of them would produce good queens. Such is not the case, however; for in general a much larger proportion of the cells formed by these eastern races produce well-developed queens. But in all hives some queen cells are undersized. This may be because they are located near the bottom or sides, where space for full development is lacking, but in many instances it arises from the fact that they are formed last, and larvæ that are really too old to make full-sized, perfect queens have to be used. These smaller cells are usually smooth on the outside and show thin walls. In selecting cells only the large, slightly tapering ones, an inch or more in length and straight, should be saved.

Yet good queens may frequently be obtained from crooked cells, in case the latter are large and extend well into the midrib of the comb.

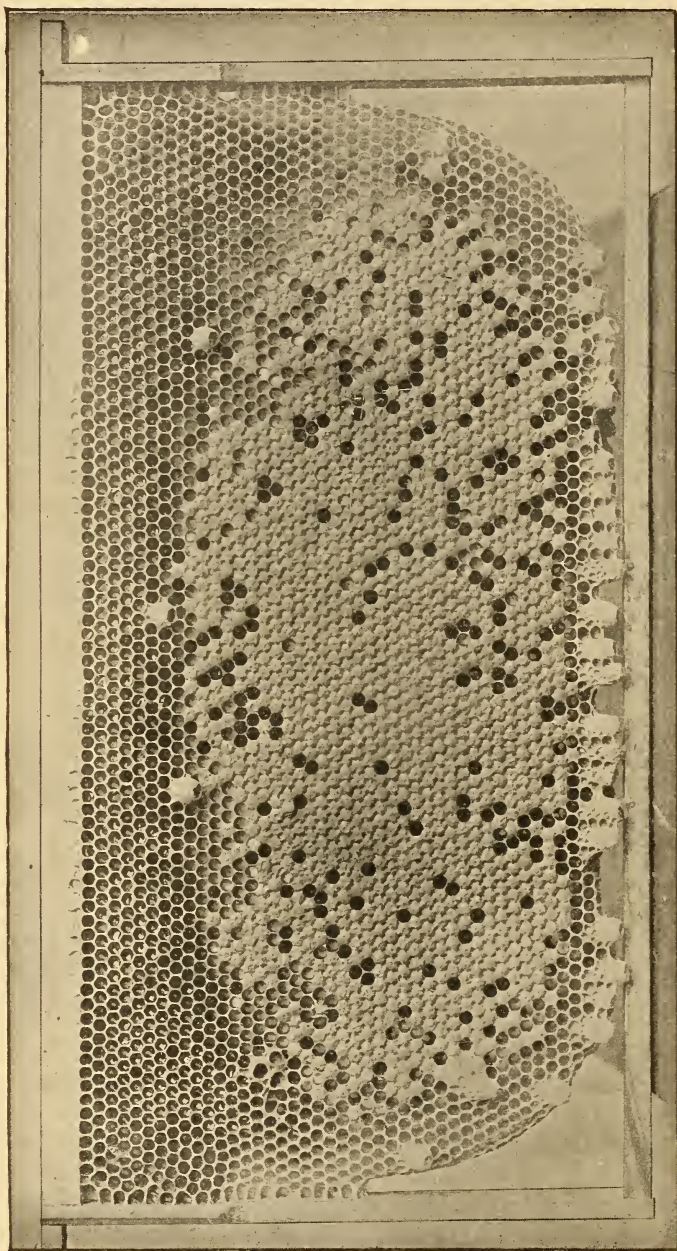

FIG. 62.—Comb showing worker brood and queen cells. (Original—from photograph.)

When a laying queen is removed from a colony during the working season, eggs and larvæ of all ages are left behind. As indicated in

Chapter II, any egg which has been fertilized may be made to develop into a queen. So also larvæ from such eggs may, up to the third day, be taken to rear from without danger of producing inferior queens. Cells in which to produce queens will be started over some of these larvæ on the edges of the combs, or, by tearing down partitions and thus enlarging the lower portion of the cell, a beginning is obtained for a queen cell. Fig. 63 shows such queen cells constructed over eggs or larvæ originally designed to produce workers. They are known as emergency cells. The young larva is at once liberally supplied with a secretion, which is probably a production of the glands of the head, and which analyses have shown to be rich in nitrogen and fatty elements, being similar to that given at first to the worker larva. This is continued throughout the whole feeding period, while, as Dr. Von Planta has shown, in the case of the workers and drones, after the third day the proportion of the constituents of the larval food is so changed that they receive much less albumen and fat and more sugar. It is chiefly the influence of this food which causes the larva that would have developed as a worker to become a queen. The latter has somewhat changed instincts, and its reproductive system is developed, instead of abortive as in the case of the worker. The size of the cell, and, to a less extent perhaps, its position, no doubt influence this development, but the food seems to be the main factor, for small cells built horizontally, if their larvæ are supplied with the food designed for royal larvæ, will be found to contain queens, and frequently these queens, even though small, are quite prolific, and show in all respects the instincts of a queen.

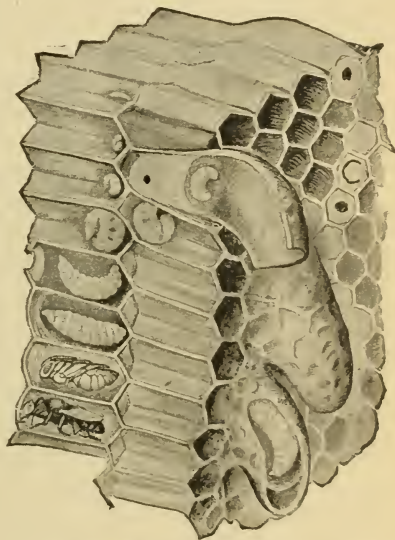

FIG. 63.—Queen cells and worker brood in various stages. (Original.)

It is believed by most queen raisers that in order to secure the best development of the young queens a colony should be allowed to build but a few cells at a time. That their belief is not well founded is shown by the facts just cited concerning the large numbers of well-developed queen cells which produce also perfect and prolific queens. It lies within the skill of the beemaster to establish conditions favoring the production of food for the queen larvæ—the so-called “royal jelly”—and this having been brought about, there need be no hesitancy in permitting the construction of hundreds of queen cells in one colony if such numbers are needed.

It was formerly the plan, after removing the queen from a colony in order to secure queen cells, to trim the lower edges of the combs con-

taining eggs or very young larvæ, or to cut out strips of comb about an inch wide just below worker cells containing eggs or just-hatched larvæ. This practice gave the bees space in which to build perfect full-sized cells, but it had certain disadvantages. Good worker combs were mutilated, often quite ruined, in order to secure the construction of the cells and also in cutting out the latter. Cells so formed are often in groups so close together that they can not be separated without injury to numbers of them, necessitating, if desirable to save all, a close watch, or at least frequent examination, for hours or even days, since all the queens are not likely to emerge at the same time.

To remedy this Mr. O. H. Townsend, of Michigan, devised a plan which is described in *Gleanings in Bee Culture* for July, 1880 (Vol. VIII, p. 322). It consists in cutting combs whose cells contain eggs or freshly hatched larvæ into narrow strips and pinning or sticking these on the sides of brood combs in such a manner that the cells containing the eggs or larvæ from which queens are desired shall open downward. Mr. Townsend removed the larvæ from some of the cells, believing that he secured better developed queens by limiting the number, and also because he could then cut them out more easily for insertion in separate hives. In the succeeding number of *Gleanings* (August, 1880), Mr. J. M. Brooks, of Indiana, illustrated a plan for securing even greater regularity. This consists in shaving off the cells on one side down nearly to the midrib of each strip of worker comb containing the eggs or larvæ selected to rear queens from, and then sticking these strips on the undersides of horizontal bars nailed in ordinary comb frames. Mr. Henry Alley, in his work on queen rearing, published in 1883, recommends sticking the prepared strips, shallow cells downward, on the lower edges of combs which have been trimmed so as to round downward. This leaves plenty of space for the full development of queen cells, the eggs or larvæ in alternate cells having been removed as in the plans previously mentioned. All conditions being favorable, many cells conveniently located are thus secured, and if the exact age of the eggs or just-hatched larvæ has been noted the time the young queens will emerge may be known beforehand, so that preparation can be made for them. Nuclei—small clusters of bees containing a quart to two quarts—are to be placed in separate hives and given combs, emerging brood, and a supply of food, and to each of these a mature cell is to be given. The nuclei thus prepared may be confined to their hives with wire cloth and placed in a cellar for two or three days, and when set out, just at dusk (p. 117), the bees will adhere to their new location. Full colonies, whose queens it is desired to replace, may also be made queenless about two or three days beforehand, and when mature the cells inserted one each in these. In cutting out the cell a small piece of comb, triangular shaped, $1\frac{1}{2}$ to 2 inches long and about $1\frac{1}{2}$ inches broad at the top, is to be left attached to it whenever practicable, since it will then be easy to insert it in one of the combs of the queenless colony

or nucleus, by cutting out a corresponding triangular piece. Fig. 54 shows a queen cell inserted in a brood comb. It is safest not to cut the cells out until they are within twenty-four to forty-eight hours of their full maturity. In case a nucleus or colony has not been queenless long enough to make it ready to accept a queen cell, the latter may be placed in a cell protector made of wire cloth or of a spiral coil of wire and then inserted between the central combs of the hive. The lower end only of the protector is open, so that the upper portion of the cell—the part easily bitten open by the workers—is wholly covered.

Queen nurseries on the general plan devised many years ago by Dr. Jewell Davis, of Illinois, are used to hold surplus maturing cells and the young queens, after emerging, for which colonies or nuclei are not ready at once. These nurseries consist of compartments about $1\frac{1}{2}$ inches square, made of wood and wire cloth, and so arranged that they may be suspended in the center of a colony of bees, a frame being filled with them for this purpose. Each compartment contains a bit of soft candy to sustain the life of the queen in case the bees fail to feed her. Spiral coils of wire somewhat longer than those used as queen-cell protectors have been arranged with a metal cup for food, so that, in principle, they are the same as the compartments of the Davis queen nurseries and are used for the same purpose.

The young queens will usually mate when from five to seven days old, flying from the hive for this purpose. If any undesirable drones are in the apiary they may be restrained from flying by means of excluder zinc over the hive entrances, permitting only workers to pass in and out. In a day or two after mating the queen generally commences to deposit eggs, and is then ready for use in the apiary or to be sent away as an "untested queen." To enable her to rank as a "tested queen" it will be necessary to keep her three weeks or a little longer in order to see her worker progeny and ascertain by their markings that the queen has mated with a drone of her own race. As both tested and untested queens are usually raised from the same mothers—the best in the given apiary—either may be obtained for honey production; but for use as breeders only tested queens which have been approved in every way should be purchased, unless, indeed, the purchaser prefers to buy several untested queens, which can usually be obtained for the price of one approved and selected breeder, and do his own testing, trusting that among them one or more may prove valuable as a breeding queen. "Warranted queens" are untested queens sent out with a guaranty that they have mated purely. If few or no drones of another race are in the vicinity of a breeder, he is tolerably safe in doing this. The proper plan is for the breeder to keep a record of the brood of all such queens and replace such as show that they have mismated.

Exact records of the ages of all queens should be kept, and notes on the qualities of their progeny are desirable, while in some instances particulars as to pedigrees are valuable.

MAILING QUEENS.

Queens are now transported nearly always by mail, and sent to all parts of the United States, and even to distant foreign countries, the cage used almost exclusively being the one shown in fig. 64 or some slightly modified form of the same. No attempt was ever made

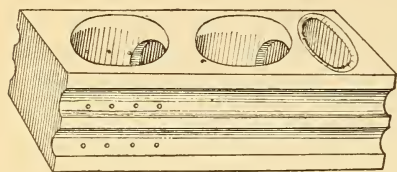

FIG. 64.—The Benton cage for transporting a queen and attendants by mail. (Original.)

to patent this cage, and as the construction is obvious from the figure given here, anyone who desires can make and use it. The food usually employed in these cages by queen breeders is a soft candy recommended many years

ago as bee food by the Rev. Mr. Scholz, of Germany. The Scholz candy is made by kneading fine sugar and honey together until a stiff dough has been formed. Some think it an improvement to heat the honey before adding the sugar. The Viallon shipping candy



FIG. 65.—Caging a queen for mailing. (Original—from photograph.)

consists of four parts of brown sugar and twelve of white sugar, with two tablespoonfuls of honey and one of flour to each pound of the mixed sugars; these, with a little water added, form a batter, which is boiled until it commences to thicken, when it is poured into the food compartment of the mailing cage. Mr. I. R. Good recommended for

use in queen cages a mixture of granulated sugar and extracted honey; hence this candy has since been known as the Good candy. The bees fed on it leave loose granules of sugar in the cage, and these becoming moist often daub the whole interior in such a way as to cause the death of queen and workers. It is therefore not adapted to long journeys.

The food for the journey having been placed in the end opposite that containing the ventilating holes, a bit of comb foundation is pressed down over it to assist in retaining the moisture, the food compartment having also previously been coated with wax for the same purpose. The cover, with perhaps a bit of wire cloth between it and the bees to give greater security, together with the address and a 1-cent stamp, completes the arrangement for a queen and eight to twelve attendant workers to take a journey of 3,000 miles. A special postal regulation admits them to the mails at merchandise rates (1 cent per ounce). For transportation to distant countries of the Pacific a larger cage and more care are necessary to success. A recent estimate by one of the apiarian journals places the number of queens sold and thus transported in the United States annually at 20,000.

INTRODUCING QUEENS.

Most of the mailing cages are arranged so that when received the removal of the wooden lid and also of a small cork at one end will permit the bees to eat their way out when assisted by those of the hive to which the queen is to be given. The cage is laid, with the wire cloth down, on the frames of a colony that has previously been made queenless. In twenty-four to forty-eight hours the queen will usually have been liberated, but it is safer not to disturb the combs for four or five days lest the bees, on the watch for intruders when their combs are exposed, regard the new queen as such, and, crowding about her in a dense ball, sting her instantly or smother her.

Colonies having only young bees accept queens readily, so that when a swarm has issued and the parent stock has been removed to a new stand the time for queen introduction is propitious. During a great honey flow queens are accepted without much question, if any at all. They may at such times nearly always be safely run in just at dark by lifting one corner of the cover or quilt of a queenless hive and driving the bees back with smoke. The new queen, having been kept without food and away from all other bees for a half hour previously, is then slipped in and the hive left undisturbed for several days. This and similar methods of direct introduction without cages, having been developed and advocated by Mr. Samuel Simmins, of England, are known as the Simmins methods of direct introduction of queens.

In the fall and at all times when honey is not coming in freely, caging the queen for a few hours or days is desirable. A cage which permits the queen to remain directly on the comb itself is infinitely superior to

any other. Fig. 66 shows a pipe-cover cage as made by the author, the size of which may be greater if circumstances require—that is, when it seems advisable, with a queen of great value, to include under the cage a number of cells containing emerging brood. Ordinarily the size here shown will suffice. The queen is caged before a closed window on a comb of honey with five or six recently emerged bees taken from the hive to which she is to be introduced. The comb holding the caged queen is to be placed in the center of the queenless colony, where the bees will cluster on it, yet with the end of the cage pressed firmly against the adjoining comb, so that the cage will remain in place even though a heavy cluster should gather on it. On the following day, just before dark, the queen should be released, provided that upon opening the hive the workers are not packed densely about the cage trying to sting her through it. In the latter case she should be left twenty-four or even forty-eight hours longer, and in the autumn it is generally advisable to keep her

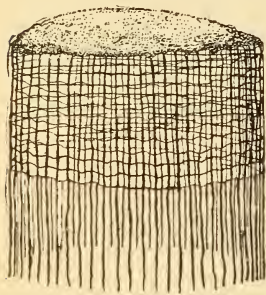

FIG. 66.—Benton queen-introducing cage. (Original.)

caged several days or even a whole week. If left longer than one day all queen cells should be hunted out and destroyed a few hours before releasing the queen. Feeding while the queen is caged is a good plan if gathering is not going on briskly. Upon freeing the queen, diluted honey drizzled down between the combs will serve to put the bees in a good humor for the reception of the new mother bee. The entrance of the hive should be contracted for a short time so that but a few bees can pass in or out at a time.

The conditions necessary to success in introducing queens are complied with by the above plan, namely: The bees are queenless long enough to have become fully aware of the fact, yet usually not long enough to have started queen cells; the strange queen is caged a sufficient length of time to acquire the peculiar odor of the hive to which she is to be given; the bees are all at home when the queen is released, and thus all become thoroughly gorged with food and are well disposed toward the new queen. No robber-bees come about, and by morning all is in order.

As queens mate only once (p. 19), and workers and drones live but a few weeks or at most a few months (p. 20), if an Italian, a Carniolan, or other choice queen mated to a drone of her own race, be introduced to a given colony the bees of this colony will soon be replaced by others of the same race as the queen introduced. All of the colonies of an apiary may thus be changed; or, from a single breeding queen the apiary may be supplied with young queens pure in blood, and, since these (even though mated to drones of another race) will produce drones of their own blood the apiary will soon be stocked with males of the desired race.

CHAPTER X.

INCREASE OF COLONIES.

NATURAL SWARMING.

An abundant secretion of honey and general prosperity of the colony—with combs crowded with bees and brood—are the immediate conditions which incite a colony of bees to swarm. If a colony in prosperous condition be found when the gathering season has fairly opened, with eggs or larvæ in partly finished queen cells, a swarm may be expected in a few days should the weather continue favorable. The first one from a given hive usually issues within twenty-four to forty-eight hours after the sealing of the first queen cell. In the case of strong colonies this may occur in favored situations in the North early in May, in the Middle States in April, and in the extreme South in March. But most of the swarms will come, in each section, a month later. When the flow of honey is prolonged the period during which swarms may issue is also extended, and in case a second flow occurs in midsummer, after an interruption, a second swarming period may occur.

The outward indications immediately preceding swarming are a partial cessation of field work on the part of colonies that have been industriously gathering and the clustering or loitering of the workers about the entrances at times when they have usually been engaged in collecting and when other colonies no more populous are at work. Apparently many are awaiting the signal to migrate, while some seem not to have caught the spirit, but continue their field work. Suddenly great excitement seizes the workers that happen to be in the hive at the time. They rush forth pellmell, accompanied by the old queen, and after circling about for some minutes cluster on some neighboring tree or shrub.

It very rarely happens that a swarm fails to cluster before leaving, but it may do so if it has swarmed before and returned to the hive because the queen failed to accompany it. Spraying water on the leaders or advance portion of the swarm from a force pump, firing a gun among them, or throwing the reflection from a mirror on them will disconcert the absconding swarm and nearly always cause the bees to settle, but the remedy must be at hand and applied instantly.

When a swarm has fairly settled it is best to hive it as soon as possible, lest others coming out may join it, occasioning a loss of queens, and sometimes of bees, or much trouble in separating them. The operation of hiving may appear very formidable to the novice and attended with

great risks, but a little experience will dispel such apprehensions. The bees before swarming usually fill their sacs with honey and are quite peaceable, so that by the use of a little smoke in hiving there is seldom



FIG. 67.—Hiving a swarm. (Original—from photograph.)

any difficulty. But to be doubly sure the novice should sprinkle sweetened water over the cluster, and at the same time wear a veil to protect his face. Of course, the hive has been ready for some time and has been standing in the shade so it will not be heated. If the cluster should be

on a small limb which can be readily cut off, it can be laid down in front of the new hive, which should have a full-width entrance or be raised up in front. The bees will go trooping in, but if not fast enough gentle urging of the rear guard with a feather will hasten matters. If the bees have clustered on a branch which it is desirable to preserve, yet where the hive can conveniently be placed directly under the cluster and close to it, the swarm may be shaken into the hive at once (fig. 67); or the hive may be located on the stand it is to occupy and the bees shaken into a large basket or into a regular swarm catcher and poured in front of the hive. If the cluster is on the body of the tree it will be necessary to place the hive near and smoke or brush the bees into it. They will go up more readily than down, and may often be dipped with a small tin dipper or a wooden spoon and poured in front of the hive. Whatever plan be pursued, expedition is advisable, and it is best before leaving them to see that nearly all of the bees are inside of the hive; at least no clusters, however small, should be left on the tree, as the queen might be among those left behind, in which case the swarm would desert the new hive and return to the tree or go wherever the queen had settled, or, failing to find her, would return to the hive whence they had issued, unless meanwhile some other swarm should issue, which they would be likely to join. A few bees flying about or crawling excitedly over the spot from which the main part of the swarm has been removed need not be heeded. They will find their way back to the stand from which they came. As soon as the swarm is fairly within the new hive the latter should be carried to its permanent stand, and well shaded and ventilated. It is better policy, however, to place the hive containing the first swarm on the stand of the parent colony at once, removing the latter to a new location. The new swarm, having the old queen, with nearly all of the flight bees, will be in prime condition for storing honey, so that supers may be placed on it as soon as it has made a fair start in its new home—that is, on the second or third day after the swarm was hived. If there are uncompleted supers on the parent colony which has been removed, they should be lifted over to the new hive on the second or third day, as the parent colony, having parted with so many of its workers, will not be able to store at once. But the new swarm, placed in a clean hive with starters only, will be in shape to store in sections at once and produce the whitest combs and honey which the source of the yield will permit.

CLIPPING QUEENS.

To prevent swarms from absconding and to facilitate the work of hiving them, as well as to keep track more easily of the ages of queens, many persons prefer to clip the wings of their queens as soon as mated. The first season one of the large or primary wings is clipped half away; at the opening of the second season the other large wing, and the third season an additional clip is taken from one of the large wings, and with

it a portion of one of the secondary or smaller wings. With finely pointed scissors this operation can be performed while the queen is loose on the combs, but there is much danger of clipping one or more of her legs also. If she be caught by her wings with the thumb and first finger of the right hand, and then grasped by the thorax with the thumb and first two fingers of the left hand, her wings can easily be reached with the scissors. It will not do to grasp the queen by the abdomen, and of course there should be but little pressure exerted on the thorax. There are some objections against clipping. The queens, being unable to fly, are liable to get lost in the grass or stray into the wrong hives when they swarm during the absence of the attendant. They certainly look unsightly when thus maimed, and occasionally the bees are more disposed to replace such queens than un mutilated ones. It is of course preferable to lose one of these occasionally rather than the whole swarm.

When the queen is clipped the operation of hiving is very easy if the bee keeper is on hand to catch the queen as she falls from the entrance to the ground. When the swarm is fairly out and while the bees are still circling in the air an empty hive should be set in place of the one from which the swarm has issued. The bees, missing their queen, will soon begin to return to their old location and will shortly crowd the entrance of the new hive. When about one-fourth have entered the queen may be allowed to run in, and the treatment will then not be different from that given any newly hived swarm.

AUTOMATIC HIVERS.

Thus far the automatic hivers have been only partially successful, so that the experimental stage has not yet been passed; but the practical perfection of such a device is looked forward to with considerable confidence.

PREVENTION OF AFTER-SWARMING.

The parent colony, removed from its old hive as soon as the first swarm issues, will rarely cast a second swarm, especially if a young queen is at hand to be introduced within a day or two. The surplus queen cells are likely to be destroyed by this young queen, with the assistance of the workers. A laying queen will be readily accepted by a colony which by swarming and removal has lost its old bees, and ten to fifteen days will be gained in the production of brood. Unless increase is especially desired it is best to limit it in this way to first swarms. If still less increase is wanted, methods which will be referred to later may be followed to prevent swarming as far as possible, and such chance swarms as do issue may be returned to the parent hive. If the queens are two or more years old, they may in most instances be profitably destroyed at this time and young ones introduced from nuclei; but whether introducing young queens or returning the swarm with its old queen, great care must be taken to destroy every queen cell, otherwise the introduced queen may be killed or the swarm may again issue. If, however, no

young queen is at hand and it is desirable to replace the old queen, all cells but one may be destroyed, but this must on no account be jarred or dented. The danger of overlooking a cell where the hive is crowded with bees makes this method somewhat uncertain; moreover, when the bees have once got the "swarming fever" they may swarm again without preparation in the way of queen cells. It is also very troublesome to remove supers to get at the brood combs. These difficulties will induce many who may wish to limit the number of their colonies to prefer hiving the swarms on starters of foundation on the old stands and giving them the supers, while the parent colonies are placed near them with entrances turned away for a few days. The flight bees return, of course, to the old stand. The parent colony should be turned a little each day so as to bring it in five or six days side by side with the hive containing the swarm, which is on the old stand, and make its front face in the same way. By lifting it a day or so later, while the young bees are flying, over to the opposite side of the old stand and turning its entrance away from that of the hive on this stand, the bees that are flying, as well as those that have marked their last location, will join the swarm; and if the same operation be repeated at the end of another week most of the remaining bees will find their way within a day or two into the hive on the old stand. About this time—that is, some fifteen or sixteen days after the issuance of the first swarm—the young queen will commence laying and may be put in place of the old one which issued with the swarm. If honey is still coming in, the young queen, with accompanying bees, may usually be safely introduced at this time by shaking them in front of the hive from which the queen has been removed, both lots of bees having been smoked beforehand so as to get them to fill themselves with honey; or the two combs between which the queen is found may be lifted, with adhering bees, and placed in the center of the colony to which the queen is to be given. Before doing this it is best to smoke the latter pretty thoroughly, and if two of the brood combs from this hive have been removed a few hours before and placed, after their bees have been shaken off, in the colony to be united, and all other combs taken away from the latter, the bees, with their queen, will be clustered on these brood combs, and they may be lifted up without disturbance and placed in the middle of the other hive, whose supers and cover are to be put in place at once and the bees left to quiet down and resume storing. Under these circumstances the loss of a queen will be very rare; nevertheless, in the case of an exceptionally valuable one, cages and other methods are advisable. (See Chapter IX.)

ARTIFICIAL INCREASE.

The time lost in watching for swarms and hiving them, the occasional losses of swarms, and the vexations attendant upon their issuance, such as their clustering in tall trees, uniting and killing queens, and the delay in their swarming when the time has come for it, have led bee

keepers to devise methods which would save their time and avoid as far as possible the uncertainties connected with this feature of their work. Where increase is desired the question is one of considerable importance. In the more northern States, where the main honey yield comes on suddenly and is abundant for a short period only, and swarming is confined mainly to a period of four to six weeks, or even to three weeks if the colonies are of pretty uniform strength, this question has less weight; but farther south, where the yield is more prolonged and the period during which swarms are liable to issue is sometimes extended over three or four months, it is of considerable moment, and the bee master who intends to multiply the number of his colonies will do well to follow some good system of control.

DIVIDING.

The simplest method of artificial increase is to lift from the populous colony a portion of the combs, with adhering bees, and place them in another hive near the parent colony, taking care that the part without any queen should have a majority of the bees and should be on the old stand. If a mature queen cell is at hand to give to this part a day or two after the division, the new colony will soon have a laying queen, should all go well. But this last point will need looking after ten days or so later. Should a laying queen be at hand to supply to the queenless portion of the divided colony, the queen found in the hive at the time of the division had better be left in that part of the colony which remains on the original stand, since the old bees will of course return to that spot and will not as readily receive a strange queen as will the removed portion of the colony which has parted with its flight bees. By introducing a laying queen when the division is made the deposition of eggs will be begun a week earlier than if a cell only should be given. At this season of the year this will make a difference of a good many thousands of workers, and will also prevent the bees from clogging the brood combs with honey, as they would if left without a laying queen for a week or more. The supers are to be placed on this part on the old stand, which, having most of the flight bees, will be far better able to store surplus than the other portion. The plan of making the division nearly equal is quite objectionable in case it is followed closely by the main honey flow of the season, for it places neither colony in the best condition for immediate storing. But if only a moderate yet continuous honey flow, followed by a larger yield, is to be anticipated, both parts will have time to become populous, and the equal division, if done in time—that is, before the “swarming fever” has taken hold of the colony—will be likely to prevent swarming.

DRIVING OR BRUSHING.

In case, however, some immediate work is expected of either part of the divided colony, it is preferable to make the division in such a way as to secure about all of the flight bees as well as most of the young

bees, which will soon become flight bees, in the hive on the old stand. This may be done by shaking or brushing nearly all of the bees from the combs of the hive to be divided, or, if the latter is a box hive, the swarm may be driven into an empty box, as described under "Transferring," in Chapter VII, and then hived as an ordinary swarm, the parent colony receiving also the same treatment as described under "Natural swarming."

THE NUCLEUS SYSTEM.

Perhaps the safest plan, considering that the yield, even when one is acquainted with the flora, can not be foretold, is to follow the plan of making nuclei, and, as soon as these have laying queens, building them up gradually to full colonies by adding frames of brood, frames filled with worker comb, or with comb foundation, or merely starters, as may seem best. This system, besides being safe, has certain other advantages. It leaves the parent hives strong for the working season, yet tends to discourage swarming, because whenever colonies become overcrowded, and before they have contracted the swarming fever, one or more brood combs are removed and the colony is thus induced to continue work in the brood chamber to fill the empty space, while, of course, they are kept supplied with plenty of storage room above for surplus honey. Furthermore, it is easy to exchange the young queen of the nucleus, as soon as she commences laying, with the queen of the full colony. If the nucleus has been started early, the full colony will thus secure a queen of the current season's raising sufficiently early to reduce greatly the probability of its wanting to swarm that year, even though permitted to get very strong, as it is almost certain to do under such circumstances. These nuclei build straight combs and may be relied on to build, even without foundation, worker comb only.

On the whole, a rational method of artificial increase is preferable to natural swarming; but experience and judgment in carrying it out are required to make it advantageous. It should be cautiously undertaken by the beginner, and the main reliance placed upon natural swarming until the bee keeper is familiar with the bees' way.

PREVENTION OF SWARMING.

The most commonly practiced and easily applied preventive measure is that of giving abundant room for storage of honey. This to be effective should be given early in the season, before the bees get fairly into the swarming notion, and the honey should be removed frequently, unless additional empty combs can be given in the case of colonies managed for extracted honey, while those storing in sections should be given additional supers before those already on are completed. With colonies run for comb honey it is not so easy to keep down swarming as in those run for extracted honey and kept supplied with empty comb. Free ventilation and shading of the hives as soon as warm days come will also tend toward prevention. Opening the hives once or twice

weekly and destroying all queen cells that have been commenced will check swarming for a time in many instances, and is a plan which seems very thorough and the most plausible of any to beginners. But sometimes swarms issue without waiting to form cells; it is also very difficult to find all cells without shaking the bees from each comb in succession, an operation which, besides consuming much time, is very laborious when supers have to be removed, and greatly disturbs the labors of the bees. If but one cell is overlooked the colony will still swarm. The plan therefore leaves at best much to be desired, and is in general not worth the effort it costs and can not be depended on.

DEQUEENING.

The removal of a queen at the opening of the swarming season interferes, of course, with the plans of the bees, and they will then delay swarming until they get a young queen. Then if the bee keeper destroys all queen cells before the tenth day, swarming will again be checked. But to prevent swarming by keeping colonies queenless longer than a few days at most is to attain a certain desired result at a disproportionate cost, for the bees will not store diligently when first made queenless, and the whole yield of honey, especially if the flow is extended over some time or other yields come later in the season, is likely, or even nearly sure, to be less from such colonies, while the interruption to brood rearing may decimate the colony and prove very disastrous to it. The plan is therefore not to be commended.

REQUEENING.

Quite the opposite of this, and more efficacious in the prevention of swarming, is the practice of replacing the old queen early in the season with a young one of the same season's raising, produced, perhaps, in the South before it is possible to rear queens in the North. Such queens are not likely to swarm during the first season, and as they are vigorous layers the hive will be well populated at all times and thus ready for any harvest. This is important inasmuch as a flow of honey may come unexpectedly from some plant ordinarily not counted upon, and also since the conditions essential to the development of the various honey-yielding plants differ greatly, their time and succession of honey yield will also differ with the season, the same as the quantity may vary. Young queens are also safest to head the colonies for the winter. The plan is conducive to the highest prosperity of the colonies and is consistent with the securing of the largest average yield of honey, since besides giving them vigorous layers it generally keeps the population together in powerful colonies. It is therefore to be commended on all accounts as being in line with the most progressive management, without at the same time interfering with the application of other preventive measures.

SPACE NEAR ENTRANCES.

Arranging frames with starters or combs merely begun between the brood nest and the flight hole of the hive while the bees are given storing space above or back of the brood-nest (figs. 68 and 69) is a plan

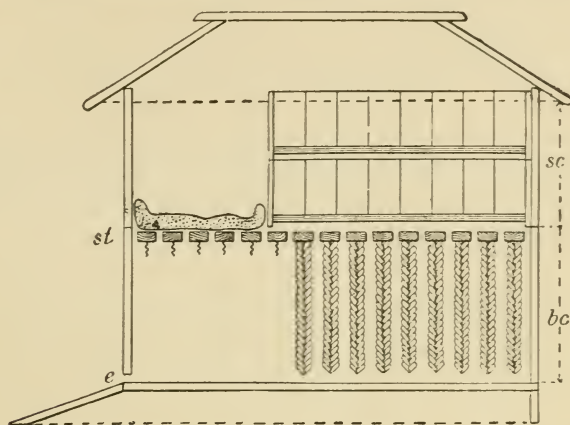

FIG. 68.—The Simmins non-swarming system—single-story hive with supers; *bc*, brood chamber; *sc*, super; *st*, starters of foundation; *e*, entrance. (Redrawn from *A Modern Bee-Farm*.)

strongly recommended by Mr. Samuel Simmins, of England, and which has come to be known as “the Simmins non-swarming method,” some features of it and the combination into a well-defined method having been original with him. It is an excellent preventive measure, though not invariably successful even when the distinctive features brought forward prominently by Mr. Simmins—empty space between the brood combs and entrance, together with the employment of drawn combs in the supers—are supplemented by other measures already mentioned; but when, in addition to the space between the brood and the flight hole, the precaution be taken to get supers on in time, to ventilate the hive well, and to keep queens not over two years old, swarming will be very limited. If to these precautions be added that of substituting for the old queens young ones of the current season’s raising, before swarming has begun, practical immunity from swarming is generally insured.

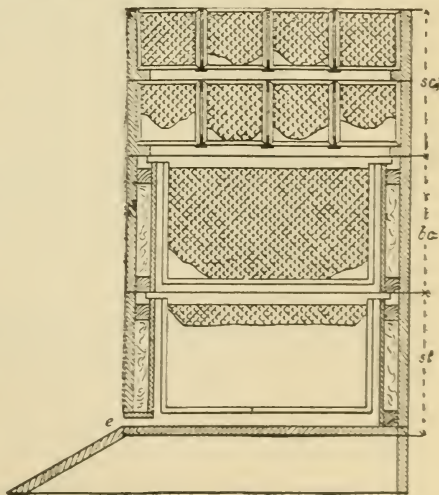

FIG. 69.—The Simmins non-swarming system—double-story hive with supers; *bc*, brood chamber; *sc*, supers; *st*, chamber with starters; *e*, entrance. (Redrawn from *A Modern Bee-Farm*.)

LANGDON NON-SWARMING DEVICE.

This device (fig. 70, *D*), first described and illustrated in *Insect Life* for April, 1893 (Vol. V, No. 4), is designed to do more than merely prevent swarming. The following claims are made by the inventor:

(1) It prevents all swarming without caging queens, cutting out queen cells or manipulation of brood combs.

(2) Two light colonies that would not do much in sections if working separately make one good one by running the field force of both into the same set of supers.

(3) No bait sections are needed, as the bees can be crowded into the sections without swarming.

(4) The honey will be finished in better condition, that is, with less travel stain, because the union of the field forces enables them to complete the work in less time.

(5) There will be fewer unfinished sections at the close of the honey harvest for the reason just mentioned.

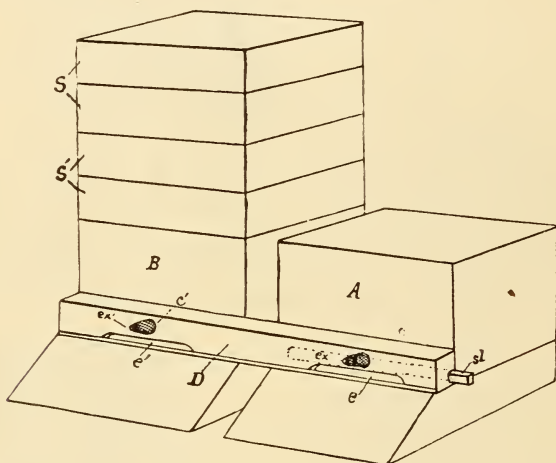

FIG. 70.—Beehives with Langdon non-swarmers attached: *A, B*, hives; *S, S'*, supers; *D*, non-swarming device; *e, e'*, entrances corresponding to hive entrances; *sl*, slide for closing entrance; *c, c'*, conical wire-cloth bee-escapes; *ex, ex'*, exits of same. (From *Insect Life*.)

(6) Also for the same reason honey can be taken off by the full case instead of by the section or holderful.

(7) Drones will be fewer in number, as a double handful will often be killed off in the closed hive while the other is storing honey rapidly.

(8) Artificial swarms and nuclei can be more easily made, as combs of brood and bees can be taken from the closed hive in which the queen can be found very quickly.

(9) It enables one to care for more than twice as many colonies as under the swarming system.

Results according with the claims mentioned above have been reported from various localities, but numerous adverse reports have also been given, the latter indicating clearly that some modification of the device is necessary if it is to be made generally serviceable. A further trial of the principle under varying conditions and climates will also be required to decide its exact value.

The manner of using the device is simple. Before the colonies swarm the device is attached to the fronts of two adjacent hives. The slide (fig. 70, *sl*) having been inserted at one end of the device, the bees returning from the fields are all run into the other hive, on which the supers are then placed. Before the colony, thus made doubly populous, decides to swarm, the slide and supers are both changed to the other hive. This is repeated every four or five days during the swarming period.

SELECTION IN BREEDING.

Some races of bees show greater inclination than others toward swarming, and the same difference can be noted between individual colonies of a given race; therefore, whatever methods be adopted to prevent or limit increase, no doubt the constant selection of those queens to breed from whose workers show the least tendency toward swarming would in time greatly reduce this disposition. Indeed, it is perfectly consistent to believe that persistent effort, coupled with rigid and intelligent selection, will eventually result in a strain of bees quite as much entitled to be termed non-swarming as certain breeds of fowls which have been produced by artificial selection are to be called non-sitters. These terms are of course only relative, being merely indicative of the possession of a certain disposition in a less degree than that shown by others of the same species. It might never be possible to change the nature of our honey bees so completely that they would never swarm under any circumstances, and even if possible it would take a long period, so strongly implanted seems this instinct. But to modify it is within the reach of any intelligent breeder who will persistently make the effort. Such work should be undertaken in experimental apiaries where its continuance when a single point has been gained will not be affected by the changes of individual fortunes.

Many features connected with swarming still remain mysteries. The whole subject requires still more study, and its full elucidation would no doubt be of great practical value to apiculture. The field is inviting.

CHAPTER XI.

WINTERING BEES.

There will be little complaint of losses in wintering bees, whether in a cold climate or a warm one, whether indoors or outside, provided the following points are observed with each colony:

(1) *The colony must have a good queen.*—By a good queen is meant one not over two years old and which shows no signs of failure during the latter part of the season. It is preferable to have a queen of the current season's raising. Such a queen, if reared from good stock and under good conditions during the latter part of the summer, will be in her prime the following spring, and if no other conditions are lacking will have her colony strong for the harvest.

(2) *Plenty of good bees.*—Bees that are several months old or that have gathered a heavy fall harvest of honey are not good to depend upon for the winter. They drop off gradually of old age before there are young bees to fill their places, and the queen, however prolific, not having bees enough to cover her eggs, can not bring up, as she otherwise would, the strength of the colony to a proper standard in time for the harvest. There should be young bees emerging at all times up to the month of October, or, in the South, even later.

(3) *Good food and plenty of it.*—Any well-ripened sealed honey that is not crystallized is good winter food. Honeydew stored by bees and honey from a few flowers (cruciferous plants, asters, etc.) crystallizes in the combs soon after it is gathered and the bees are obliged to liquefy it as they use it. They can not do this well in dry, cold weather, and dampness within the hive, though it might enable the bees to liquefy the crystallized honey, is otherwise inimical to bee life, especially so during winter. Some of the crystallized food is also wasted; hence the bees may starve even though the fall weight indicated sufficient stores for winter. Disastrous results are very likely, therefore, to follow the attempt to winter on such food.

The removal of all pollen when preparing bees for winter has been advised by some, who assert that it is unfit winter food and produces dysentery. It will not, of course, alone sustain the life of the adult bees, but if all conditions are right no more of it will be eaten than the bees require to repair the waste of bodily tissue, and this being slight in winter the consumption is small as long as other food lasts. The pollen grains which by accident find their way into honey as the bees gather it would probably be quite sufficient to supply this waste in the case of the adult workers and no harm would result to these bees from the

substitution of other combs for those containing pollen. But good colonies should begin brood rearing in January or February, and pollen or a suitable substitute for it containing nitrogen must then be present or the nurse bees will be subjected to a fearful drain on their vitality to supply the rich nitrogenous secretion required by the developing larvæ; in fact, they can not do so long, and the colony dwindles. This absurd theory that bees can not have access to pollen in winter without detrimental results can best be answered by referring to the well-known fact that a colony in a large box or straw hive, freely ventilated, yet having some part of the hive protected from drafts of air and kept dry, will almost invariably come out strong in the spring if populous in the fall, heavy with honey, and having a young and vigorous queen. The

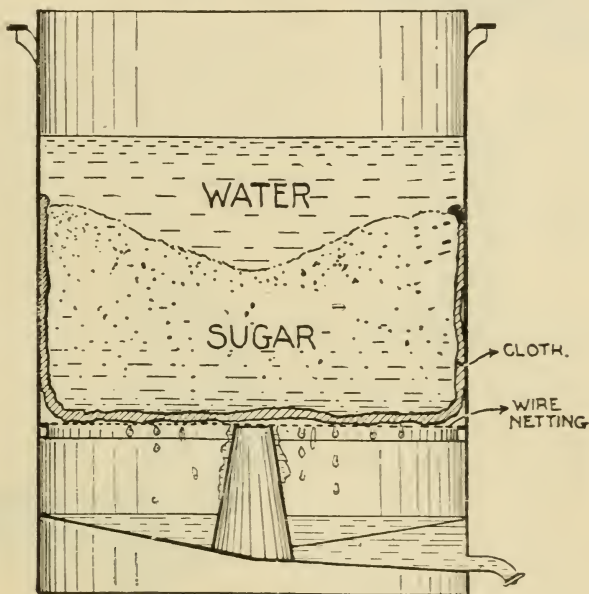

FIG. 71.—Percolator for preparation of winter food. (Original.)

pollen, it could not possibly be claimed, had been injurious to such colonies, although they always gather and store it without restriction, and are not disturbed in the possession of it. In truth, their stores of pollen have constituted an important factor in their development, and the strong instinct which they have toward making accumulations of pollen for winter use and which they have exercised for thousands of years undisturbed is of great benefit to them.

Other conditions being equal, those colonies having the most honey stored compactly in the brood apartment and close about the very center where the last brood of young bees should emerge, are the ones which will winter best. Forty pounds for a northern latitude and 30 in the middle sections of the United States may be considered only a

good supply. When natural stores are found to be lacking in the brood chamber, the best substitute is a sirup made of granulated sugar, which should be fed early in the autumn as rapidly as the bees can manipulate it and store it away. If given slowly the bees will be incited to rear brood unseasonably, and will consume much of the food in this way. If several pounds be given at a time—placed in the top story of the colony to be fed, just at night-fall—it will be stored away quickly, so that in a week at most the full winter stores will be completed. The bees will seal it over better if fed slowly at the last; that is, after the main feeding. Sirup made by percolation of cold water through a

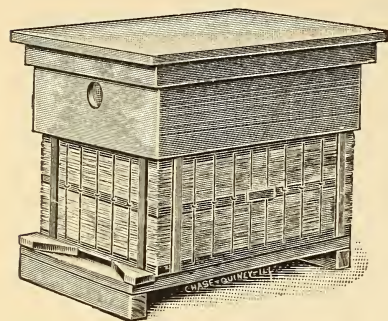

FIG. 72.—The American straw hive of Hayck Bros.

mass of sugar and then through some porous material, as cotton, is what is called a completely saturated solution; that is, it contains all the sugar the water can be made to hold, and will not trouble by granulation (fig. 71). The same difficulty is avoided by adding well-ripened honey to moderately thick sirup, about one-fourth or one-fifth as much honey as sirup. Molasses, brown sugar, glucose, etc., are not suitable for winter stores for bees.

It is poor policy to permit bees to enter winter quarters without an abundance of stores—better twice the amount that will be actually consumed than merely enough to enable them to live through.

(4) *The bees must be kept dry and warm.*—A substantial hive with a tight roof will keep rain and snow from the cluster; but the bees must have air even during the severest weather and also when in their most quiescent state; hence the question of ventilation has to be considered. It has occasioned more discussion and experimentation than any other point concerned in the wintering of bees. The amount of ventilation both indoors and outside, whether upward ventilation or lower ventilation, or both, and whether through the wooden walls of the hive alone,

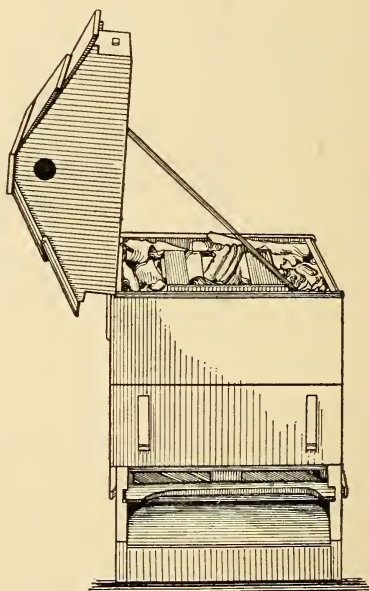

FIG. 73.—Davis hive with newspapers packed between inner and outer cases, and brood frames on end for the winter. (Original.)

have given rise to thousands of experiments based on all sorts of theories, and innumerable losses have resulted. The matter is really more complicated than would seem at first thought. The warm air about the bodies of the bees (the winter temperature of the cluster being about 72° F.) coming in contact with the cold surfaces of combs of honey in ordinary hives, or with the inner walls of such hives, condensation and deposition of moisture occurs. During severe weather this accumulates in the shape of hoarfrost, which, melting with a rise of temperature, trickles down over the combs, the walls of the hive, and the bees themselves, and, entering the honey cells through the somewhat porous capping, sours the honey with which it mixes. The soured food, dampness, and chilling of the bees combine to bring on diarrhea, which is sure to weaken and decimate the colony if it does not exterminate it. To avoid these troubles the surplus moisture of the hive must be carried away by free ventilation, which at the same time supplies pure air, but which does not create drafts in the hive nor permit such an escape of heat as will chill the cluster through. Straw hives (fig. 72) do this well; also the forms shown in figs. 73 and 74 if well packed over the combs and ventilated above the packing.

(5) *There should be no manipulation out of season.*—Breaking up the cluster and exposing the individual bees and their combs to a low temperature, as well as causing them to gorge themselves with honey when an opportunity for a cleansing flight may not occur soon, are also causes which bring on diarrheal difficulties. Feeding to complete the winter stores, when necessary, should be done soon after the last honey flow, so that the bees will settle down for the winter on the approach of cool autumn days. After this they are better off if left undisturbed until the final work of preparing them for winter is done, which, if the hive is well arranged, will be no material disturbance to the bees. It is always preferable not to be obliged to touch the brood combs or disturb the cluster when the weather is too cold for the bees to fly freely.

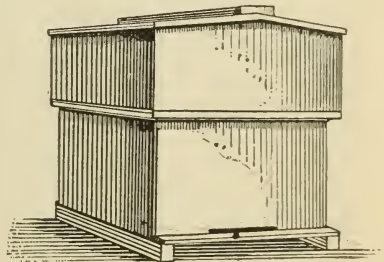

FIG. 74.—Double-walled hive adapted to outdoor wintering as well as summer use below 40° north latitude in the United States. Thickness of each wall, $\frac{3}{8}$ inch; space between walls, 2 inches, packed with dry chaff or ground cork. (Original.)

OUTDOOR WINTERING.

A consideration of the requirements above mentioned leads at once to the essential features of any plan of outdoor wintering that may be followed in the colder portions of our country with uniform success, namely, the presence in the colony of a vigorous queen less than two years old; a good cluster of healthy bees bred the latter part of the season, that is, of sufficient numbers so that when closely clustered

during quite cool weather late in October or November not less than six spaces between the brood combs, and preferably eight or nine spaces, shall be occupied by a good number of bees, or that the cluster shall be at such a time not less than 8, and preferably 10 to 12, inches in diameter; the stores should consist of 30 pounds of well-ripened honey or thick sugar sirup, stored and mostly sealed over and about the bees; since in a long, shallow hive the heat is too diffused, combs much longer than deep should be on end for the winter, to enable the bees to economize their natural warmth; free access of pure air, but without the creation of drafts, hence the entrance should be indirect or screened in some manner; the ventilation should permit the gradual passing away of the moisture-laden air of the hive, but not



FIG. 75.—An apiary in Vermont—winter view. (Reproduced from photograph.)

the escape of heat, hence 6 or more inches (in the coldest portions of the United States 10 or 12 inches) of dry, porous material, soft and warmth-retaining, should be on all sides of the cluster and near to it, the whole being protected by waterproof walls from any access of outside moisture. Care to establish in all cases conditions similar to the above before bees cease flying in the autumn will insure the apiarist against any serious losses in wintering out of doors, even in the severest portions of our country.

In the extreme South, where bees can fly out at any time of the year, little extra precaution is needed for the winter beyond seeing that the stores do not become exhausted during a drought or a protracted rain, when no honey can be gathered. Just in proportion to the severity and length of the winter season the above general rules may be looked upon as applicable, always bearing in mind, however, that in the variable climate of the middle section of the country many of the pre-

cautions strictly essential in a colder climate may still be profitably followed, although fair results may be expected in the main without their strict observance.

INDOOR WINTERING.

Dry cellars or special repositories are utilized in those portions of the country where the cold of winter is extreme and likely to be somewhat continuous. Economy of food is one of the chief advantages, but two-thirds as much, or about 20 to 25 pounds per hive, are needed to bring a colony through if conditions are favorable. The colonies, prepared as regards bees, queens, character of stores, etc., the same as for outdoor wintering, are carried into the cellar or repository just before the first snows come or severe freezing occurs. Caps are removed or lifted up and cushions or mats laid on the frames. Light is excluded and all other disturbing influences in so far as possible, the effort being made to keep the temperature at about 42° F. during the earlier part of the winter. Later, especially after brood-rearing may have been begun, a somewhat higher degree is admissible—45° to 46°, some even allowing it to go up to 50°. No definite rule can be given, however, since much depends upon the humidity of the air, etc. As long as the bees remain quiet the temperature is not too high and is preferably to be maintained. Should they become exceedingly restless, and the opportunity occur during a winter thaw to give them a cleansing flight, it will be advisable to return them for a few hours or a day or two to their summer stands, and when they have flown and quieted down, replace them in the cellar or repository. In the spring there should not be too great eagerness to get them out of the cellar, provided they are not restless. Their confinement indoors makes them somewhat sensitive to the outside cold, and due caution should be observed, else the ranks of the workers will become greatly decimated before young ones appear to take their places.

The same questions regarding ventilation of hives indoors that puzzle many in the case of those left on their summer stands have been discussed over and over. All that is necessary, however, is to consider the same points, the question being less complicated, though, by reason of the greater uniformity between the temperature surrounding the cluster of bees and that outside the hive when the latter is in a suitable winter repository. Some have reported success in wintering in damp cellars, yet it is probable that such success was purely accidental, or rather occurred in spite of the dampness of the repository, the other conditions very likely having all been favorable, especially as regards ventilation of the cellar, and the important points of having good stores and an even temperature, which should be several degrees higher than is required in a dry cellar. Wintering in a damp repository is, however, attended in general with such risks that it should by all means be avoided, and the bees, even in a severe climate, intrusted preferably to their summer stands, if well prepared as regards their stores and populousness.

CHAPTER· XII.

DISEASES AND ENEMIES OF BEES.

DIARRHEA AND DYSENTERY.

In the chapter on wintering bees allusion has been made to certain conditions which bring about diarrhea in bees. Not only will soured or fermented honey produce this disease, but thin honey also, by requiring too great exertion on the part of the bees to get rid of the surplus moisture taken into their bodies, may indirectly cause the disease. Repeated complaints have been made by those located near cider mills that the apple juice collected by their bees was the cause of diarrhea and dysentery. Aphidid secretions sometimes have the same effect. Prolonged and intense cold in the interior of the hive, especially if the stores are not of the best quality, causes distention and resulting weakness and soiling of the hive and combs. Dampness and chilling of individual bees frequently cause it. The effort some make to avoid the dampness often results in the chilling, for the cover is removed, and also some portion of the packing or the quilt or honey board to let the air pass through to dry the interior. The true remedy is a cleansing flight and warmth in the hive. Should the weather not be favorable for this out of doors, the hive may be brought into a warm room and a cage of wire cloth 2 or 3 feet square placed over the entrance. When thoroughly warmed up the bees will fly in this and find their way back into the hive. It is best to leave them in the warm room two or three days, lowering the temperature gradually before returning the hive to its outside stand.

FOUL BROOD.

This disease, being highly contagious, is dreaded most of all by the bee keeper. It is due to the presence of minute vegetable organisms in the body of the bee, the larva, or the egg, which prey upon its tissues. These, as Prof. Frank Cheshire has shown, are bacilli, which, multiplying with marvelous rapidity by division and also by spores, are carried from hive to hive, until from a single infection the whole apiary is soon ruined. The particular bacillus which is commonly known as foul brood Professor Cheshire has described as *Bacillus alvei*, or hive bacillus, as it affects not only the brood but also the adult bees. (See Pl. XI.) The first symptoms noticeable in the hive are its lack of energy, then dead larvæ turned black in the cells, and finally sunken caps, some of them perforated slightly over larvæ and pupæ. All of these symptoms may,

Fig. 1 x 700.



Fig. 2 x 700.

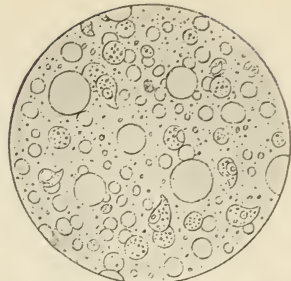

Fig. 5 x 4.

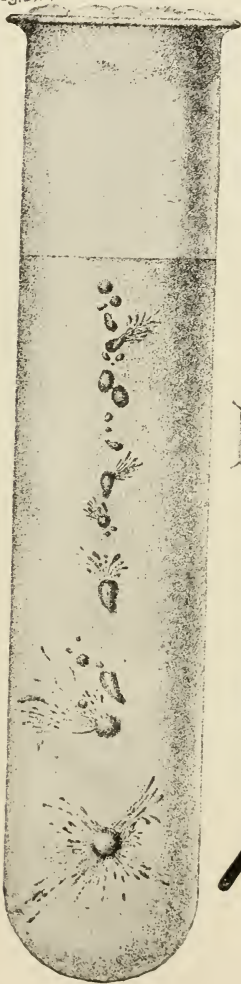

Fig. 3 x 600.



Fig. 6 x 4.

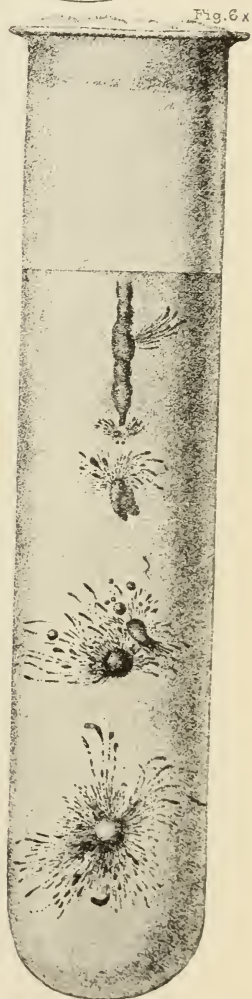

Fig. 4 x 3.

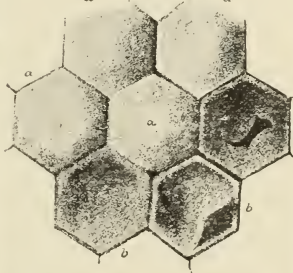

Fig. 7.



Fig. 8.



BACILLUS ALVEI (Cheshire).

[Drawn from nature by Frank R. Cheshire for Jour. R. Micr. Soc., and here reduced one-sixth from the original plate.]

- FIG. 1.—Residue of larva three days dead of *bacillus alvei*; *b*, bacilli. Spores and degenerated tracheae cover the field.
- FIG. 2.—Healthy juices of bee larva.
- FIG. 3.—Juices of larva (living) with disease in acute stage; *a a*, lepto thrix forms.
- FIG. 4.—Brood cells from a diseased colony; *a a*, cells containing healthy pupae; *b b*, sunken and punctured cells in which pupae have died.
- FIG. 5.—Cultivation in sterilized agar-agar showing the colony form of bacillus.
- FIG. 6.—Same cultivation twenty-four hours later.
- FIG. 7.—Spore changing into bacilli.
- FIG. 8.—Bacillus passing into spore condition.

however, be present when no foul brood exists; but if, upon opening some of the cells whose caps are sunken or slightly punctured, a brown, ropy, putrid mass is found, which, when lifted on the end of a sliver of wood, glides back into the cell or strings down from the mass like thick sirup, it is pretty certain that foul brood is present. Caution is necessary or it may be spread all through the apiary. The hands, as well as all tools used about the infected colony, should be cleansed by washing in a solution of corrosive sublimate (one-eighth ounce dissolved in 1 gallon water) before going to another hive. If but few are found diseased they should be burned at once—at night, when all the bees are at home. If all or nearly all are affected, or if the disease does not seem virulent and other apiaries in the neighborhood are not endangered thereby, a cure may be attempted. Removal of all of the combs and confinement of the bees in an empty box, obliging them to fast until some drop from hunger, followed after releasing them by liberal feeding, will frequently effect a cure, as indicated many years since by Mr. M. Quinby. The hives may be disinfected by washing in carbolic-acid water and used again. A second removal of the bees and fasting may be necessary in some cases. It will also be well to feed medicated sirup—1 part of carbolic acid, or phenol, to 600 or 700 parts of sirup. Many omit the fasting, but destroy all combs and frames and supply comb-foundation starters, removing four days later all combs built and giving a second lot of starters. It is well to supplement this treatment with feeding of medicated sirup. Phenol having been suggested to Professor Cheshire as a remedy, he experimented until he found that if a sirup containing 1 part of phenol to 400 or 500 parts of the food be poured in the cells adjacent to the brood, and the diseased brood, after brushing off the bees, sprayed with a solution of 1 phenol to 50 water, a cure was speedily effected. The great risk of spreading the disease, as well as the time and expense which a cure by drugs or by the fasting process involves, will cause immediate destruction to be resorted to as the cheapest in the end if taken in time.

Bacillus gaytoni, also described by Professor Cheshire, is characterized by loss of hairy covering on the part of the workers and their crawling out of the hives over the ground, constantly wriggling their bodies until death occurs. It yields, according to Professor Cheshire, to the same remedies as *Bacillus alvei*, but having been less destructive and being far more likely to disappear without effort to cure it, less attention has been given to it. Lately, however, it has been alarmingly destructive in some of the extensive apiaries of California, Colorado, and Texas, so that some simple remedy would be very welcome.

THE WAX OR BEE MOTH.

The larva of a moth known to entomologists as *Galleria mellonella* Linn. gnaws passages through the combs of the bees, especially those in or near the brood nest, often proving very destructive in weak or neg-

lected colonies. The popular name, wax moth, was doubtless given on the supposition that the food of the larva was chiefly wax; but when an attempt to rear them on this substance in its usual commercial purity is made slight development only results. Probably chemically pure wax would not be touched by the larva; but in combs containing the larval skins left by developing bees, or containing brood or pollen, they reach their highest development if left undisturbed during warm weather, finding ample nourishment in the nitrogen-containing pollen and animal tissues left by the molting larvæ. To protect themselves from the bees they line their galleries through the combs with a strong web of silk and are able to retreat or advance rapidly through them when attacked. The observing bee keeper will occasionally notice the moths resting during the daytime on the corners of the hives or under the roof projections or edges of the bottom boards. Its color is dull or ashy gray, with light and dark streaks, making it so nearly like a protruding sliver of a weather-beaten board as to protect it materially from its enemies when resting on any unpainted surface that has been long exposed. At nightfall the moths may be seen flitting about the hive entrances, seeking an opportunity to enter and deposit their eggs. If prevented by the bees, which are then instinctively on the alert, they deposit in the crevices between the hive and stand or between the hive and cap. The minute larvæ as they emerge soon make their way into the interior of the hive. It is possible also that some of the eggs of the moth may be left where the bees crawling over them carry them into the hive by accident, the freshly laid egg adhering readily to any substance it touches. In the northern and middle sections of the United States two broods are reared, the first appearing in May, the second and larger brood in midsummer or even August. The eggs deposited by the last brood develop slowly in the cooler autumn weather, but usually reach the pupal stage, in which they normally pass the winter. Individual moths may, however, be seen about the apiary during June and July, and even into the autumn, so that egg deposition is constantly going on, and any combs removed from the hive and left unprotected by bees, especially if in a warm apartment or a closed box, will soon be in complete possession of the destructive larvæ, which wax fat and soon reduce them to a mass of webs. The only remedies are to keep the combs under the constant protection of the bees, or, if the colonies are not populous enough to cover them fairly, the combs should be hung so as to leave a space between them in a cupboard or large box which can be closed tightly, so as to subject them for some time to the fumes generated by throwing a handful or two of sulphur on live coals, or to the odors of bisulphide of carbon in an open vial. Caution is needed in the use of the latter, since it is highly inflammable.

Oriental races of bees are more energetic than others in clearing out wax-moth larvæ, and Carniolans and Italians more so than the common bees. But in colonies always supplied with good queens

the wax-moth larvæ make little headway, and it is therefore only the neglected hives that are seriously troubled. Moth-trap attachments or moth-proof hives are therefore of no use, unless, in the case of the former, larvæ seeking a secure place in which to pupate may be caught; but that implies frequent examination, and the same or less attention to the colony itself will suffice to do away with almost any breeding of moths. Hives proof against the entrance of wax-moth larvæ would, as the statements here made regarding the breeding habits of the moth indicate, exclude the bees also. From the foregoing it can be readily seen that the attentive apiarist no longer regards the wax moth as a serious pest.

BRAULA OR "BEE LOUSE."

A wingless dipteran, *Braula caca* Nitsch, known under the common name of "bee louse," is a troublesome parasite on bees in Mediterranean countries, the adults, which are very large in proportion to the host, gathering on the thoraces of the workers, rarely of the drones, but in great numbers on the queens. The writer has removed seventy-five at one time from a queen, though ordinarily the numbers do not exceed a dozen. When numerous they render the queen weak by the removal of vital fluids. The insect has frequently been imported to this country on queens with attendant bees, but thus far has probably gained no foothold. Likely it will never do so in the North, but the case might be different in any region resembling southern Europe in climate, and it is by all means advisable to remove every one from any queen or worker arriving here infested with them.

OTHER ENEMIES.

Robber flies, dragon flies, etc.—Several species of *Asilus* and related predaceous Diptera do not live upon injurious insects alone, but also capture and devour honey bees. They are more destructive in the South than elsewhere. The same is true of the neuropterous insects known as mosquito hawks, dragon flies, or devil's darning needles. There seems to be no remedy for any of these except that of frightening them away when noticed about the apiary. The "stinging bugs," belonging in the hemipterous family Phymatidæ, often capture and destroy workers as they visit the flowers. No remedy is practicable.

Ants and wasps.—Some of the larger ants and social wasps are very troublesome to the apiarist in tropical and even in subtropical regions. They seize the workers and cut them in pieces with their powerful jaws. Having once reduced the hive defenders, they even make bold to enter and carry off the queen as well as help themselves to honey. Trapping them with honey or with meat and killing them, as well as destroying the nests when found, are the only remedies. The paper nests are easily burned away, while an effectual remedy against ants is to open the hill and pour in an ounce or two of bisulphide of carbon.

Spiders.—Webs made about hive entrances often capture bees as well as wax moths, and, notwithstanding this last-mentioned point in their favor, they had better be removed.

Toads and lizards.—These devour many bees, and whenever found near the hives should be destroyed or removed to the vegetable garden.

Birds.—Swallows and kingbirds have been accused of eating many bees. It is probable that the destruction of injurious insects by them more than makes amends for the bees taken. This was clearly proven in the case of the kingbird, stomachs of which, examined at the United States Department of Agriculture, showed only a very small percentage of honey bees, and these mostly drones.

MAMMALS.

Mice gaining access to the hive during winter gnaw out among the combs a nest cavity and eat honey, pollen, and bees. Low entrances, covered, if found necessary, with a strip of tin, will prevent the mice from gnawing larger holes, yet permit the bees to pass in and out. Skunks sometimes disturb hive entrances and catch bees as they come out. This is particularly vexatious in the winter, when colonies should be left quiet. In mountain localities, bears, led by their fondness for honey, still occasionally overturn beehives. The remedies for both of these are, of course, shooting or trapping.

ROBBER BEES.

When forage is scarce in the field, bees belonging to different colonies often wage fierce wars over the stores already in hives. Thousands are killed and the victors relentlessly carry off as booty every drop of honey from the vanquished hive, leaving its bees to starve miserably. A great stir and loud buzzing in the hive of the conquerors attests their rejoicing over the ill-gotten gains. Nor have they any code of morals which inclines them to select as opponents forces equal in strength to their own. With them "all's fair in war." Their only object is plunder, and they therefore select the most defenseless, a colony disorganized through loss of its queen being an especial mark for a combined attack.

Extreme caution to prevent robbing is always advisable. A little carelessness or neglect in the apiary early in the spring or toward the latter part of the season may result in much loss. It is easier to prevent robbing than to check it at once or without loss after it is well under way. Leaving honey exposed about the apiary often induces robbers to begin their work; hence extracting and similar work must be done in bee-proof rooms whenever the bees are not gathering honey freely. It may at such times be necessary to do all manipulating early in the morning, before many of the bees have begun to fly, or later in the day, after they have ceased, or even under a tent made of mosquito netting and placed temporarily over the hive to be manipulated. Queenless and weak colonies should be put in order if possible before the honey

flow ceases. In any event the entrances of such hives should be contracted until but few or even no more than one bee can gain access to the interior at one time. Professor Cheshire has devised an excellent entrance block to prevent or check robbing. This is shown in fig. 76, and is so simple that anyone can make it. When contracted and placed at the hive entrance it will be seen that the robbers must make their way through a narrow and bent passage, something they are loath to attempt, especially if at the first onset they find the passage well guarded.

If robbing has begun it may sometimes be stopped by throwing coarse grass or weeds over the entrance of the hive attacked, or by leaning a pane of glass against its front, the entrance being, of course, contracted as indicated above. These plans tend to confuse the robbers for a time, and meanwhile the rightful occupants of the hive may be able to organize for defense. If convenient the colony attacked may be moved a distance of a half mile or more and placed as far as possible from other apiaries until it can recuperate. Another plan in extreme cases is to put the colony in a dark cellar for a few days, confining the bees to the hive with wire cloth, so as to allow plenty of ventilation, as described under the head of "Moving bees." When

brought out of the cellar it is well to place the colony on a new stand, apart from the other bees, contract the entrance, and lean a board against the front of the hive. It is also safest to bring it out late in the day, even just at dusk, so the bees will begin



FIG. 76.—Cheshire anti-robbing entrance: *st.*, stationary piece; *s.*, slide; *p.*, pin or stop. (Redrawn.)

flying from it gradually and not attract the attention of robbers. It may be well, when removing a colony from its stand to save it from robbers, to put in its place a hive with combs containing a little honey and pollen. The robbers, instead of scattering and entering adjacent hives, will continue to visit the same stand, their numbers gradually diminishing as the honey gives out and the pollen is sucked dry. If meanwhile the entrances of adjoining hives have been contracted and these colonies are fairly strong and in normal condition, individual robbers will be successively repulsed as they appear. Quiet will thus be eventually restored.

LAYING WORKERS.

Although laying workers are not strictly enemies of their kind, their work hastens the extinction of the colony to which they belong, in case the latter has become queenless and is without the means of rearing another queen. They cause the expenditure of the stores and strength of the colonies in a vain though well-meant endeavor to perpetuate their species; the eggs which laying workers deposit, and for whose development through the larval stage much honey and pollen are

required, only resulting in the production of a lot of drones, for the most part weak and dwarfed.

If not discovered until the hive is nearly depopulated, the remaining old bees should be brushed off, and the combs, after the sealed drone brood has been uncapped and jarred out, may be distributed among other colonies. Should the affected colony still be worth saving, combs containing emerging bees should be added and a queen introduced a few days later, or a queen cell inserted, as soon as the added brood has stocked the hive well with young bees.

BOOKS AND JOURNALS RELATING TO APICULTURE.

The following are among the leading books and journals relating to apiculture:

BOOKS.

- Langstroth on the Honey Bee. Revised edition, 1889. By Chas. Dadant & Son.
 Quinby's New Bee Keeping; or The Mysteries of Bee Keeping Explained. 1884.
 By L. C. Root.
 The A B C of Bee Culture: A Cyclopædia of Everything Pertaining to the Care of the Honey Bee. By A. I. Root.
 Advanced Bee Culture: Its Methods and Management. 1891. By W. Z. Hutchinson.
 Bees and Bee Keeping, Scientific and Practical. By Frank R. Cheshire. In two volumes: Vol. I (scientific), Vol. II (practical). Published in London, England.
 The Bee Keeper's Guide; or Manual of the Apiary. By A. J. Cook.
 A Modern Bee Farm and its Economic Management. By S. Simmins. Published in London, England.
 The Blessed Bees. By John Allen.
 Bee Keeping for Profit. By Dr. G. L. Tinker.

JOURNALS.

- The American Bee Journal. Weekly. Chicago, Ill.
 Gleanings in Bee Culture. Semimonthly. Medina, Ohio.
 The Bee Keepers' Review. Monthly. Flint, Mich.
 The American Bee Keeper. Monthly. Falconer, N. Y.
 The Progressive Bee Keeper. Monthly. Higginsville, Mo.
 The Southland Queen. Monthly. Beeville, Texas.
 The Western Bee Keeper. Monthly. Denver, Colo.

